

# C.S. OSBORNE & CO.



Manufacturing the Finest Upholstery Tools for the Professional



Automotive



Furniture



Awning, Canvas & Marine

# C. S. OSBORNE & CO.

ESTABLISHED 1826

125 Jersey Street  
Harrison, N.J. 07029 - U.S.A.  
Phone # (973) 483-3232  
Fax #(973) 484-3621  
E-mail address: [cso@csosborne.com](mailto:cso@csosborne.com)  
[www.csosborneupholsterytools.com](http://www.csosborneupholsterytools.com)

## TOOLS FOR UPHOLSTERERS, AUTO TRIMMERS AWNING AND CANVAS WORKERS



Since 1826, the Osborne family has dedicated itself to providing the very finest tools. Aply assisted by employees who average over ten years of service to the company, the eighth generation of the Osborne family still manages the firm and continues the tradition requiring strict adherence to the highest standards of quality and service. This dedication continues to provide the best possible hand tools for the professional.

### PRICING

All orders are accepted on the basis of price in effect at the time of shipment.

### OUR GUARANTEE

We will replace, free of charge, any tool which may prove unsatisfactory in performance if sent for inspection, freight prepaid. Tools which are known to have given reasonable service, or have been misused, or damaged, will not be considered defective.

## PRODUCT INDEX: ALPHABETICAL

Awl, All Purpose	90	Key, Moulding Release	75	Pliers, Decorative Nails Remover	17
Awl, Automatic	91	Klinch-It-Tool	32	Pliers, Duckbill	25
Awl, Haft	91-92	Klinch-It-Fasteners	32	Pliers, Hog Rings	70-72
Awl, Peg Haft	92	Knife, Bevel Point	77	Pneumatic Machines	41
Awl, Badminton	90	Knife, Broad Point Knife	77	Polywasher, Nylon	49
Awl, Saddlers	92	Knife, Hawkbill	76	Prongs, Prong Washers	46
Awl, Scratch	90	Knife, Skiving	76	Punch, Aligning	81
Awl, Sewing	92	Knife, Skiving Blade	76	Punch, Arch	82
Awl, Stabbing	92	Knife, Sharp Square Point	77	Punch, Belt	85
Awl, Stitching	92	Magnetic Nail and Tack Placer	9	Punch, Center	81
Awl, Tennis	90	Mallet, Hickory Barrel	79	Punch, Drive	81
Basket & Weaving Tools	88	Mallet, Hickory Tinner's	79	Punch, Mini	84
Bazooka, Filler	22	Mallet, Poly	79	Punch, Oblong Cutting	84
Belt Punch	85	Mallet, Rawhide	78	Punch, Pin	81
Bone Folders	89	Mallet, Rubber	79	Punch, Revolving	86
Button Backs	44-50	Marine Canvas Tools	62	Punch, Self-Centering Set	84
Button Chart	40	Mauls, Nylon & Rawhide	80	Punch, Solid	81
Buttons, Combinations	44, 50	Metal Webbing Stretcher	30	Punch, Ventilator	65
Button Machines	40-41	Monofilament Thread	53	Regulators, Plastic Handle	53
Buttons, Plastic	48	Moulding Clip Tool	75	Regulators, All Metal	53
Button & Foam Cutters	23	Moulding Lifter	36	Removers, Castor Socket	29
Button Dies	43	Nailer, Pneumatic	15	Release Key, Headset	75
Button, Double	48	Nails, Decorative	12-15	Remover, Staple	17-19
Button Instructions	42	Nails, Threaded & No Dent	47	Remover, Clip & Door Handle	75
Carboard Wad	49	Nail Spacer	16	Remover, Trim Pad	75
Castor Socket Remover	29	Nail Pliers Remover	17	Retainer Clip Installer	75
Chalks, Marking	38	Nail Button Driving Tool	47	Rings, Hog	72
Chisel, Caning	88	Needle, Assortment	96	Rings, Plastic Snap	48
Chisel, Ripping	35-36	Needle, Bent/ Straight Pack	102	Rivets, Copper	87
Chisel, Straight	36	Needle, Bird Pelt	99	Rivet, Setter	87
Clasps, Tufting	51	Needle, Bolster	100	Roller, Carpet	74
Claw Tools	18	Needle, Canning	88	Rulers, Aluminum & Wood	39
Clips, 3 Prong	31	Needle, Carpet	102	Screw Stud	64
Clips, EK	31	Needle Chart	94	Seam Ripper	76
Clips, Lined BW	31	Needle, Chenille	101	Seam Stretcher	22
Clips, Rubber & Webbing	28	Needle, Collar	99	Shells	45
Combination Tool	36	Needle, Curved	97, 98	Sheath, Knife	77
Collets	49	Needle, Curved Leather Point	98	Shears	66-69
Connectors, Spring & Wire	32	Needle, Flocking	100	Snaps	63-64
Cutter, Button	43	Needle, Glovers	101	Snap Dies, Kits	60
Cutter, Side	19	Needle, Harness	101	Snap Rings	48
Cutter, Turn Button	61	Needle Kits	95	Snap Setters	58, 60
Cutter, Curtain Fastener	61	Needle, Lampshade	97	Stone, Sharpening	76
Cutting Pad	84	Needle, Loop	52	Spring Bender	29
Dies, Snap	54, 60	Needle, Mattress	98	Spring Connectors	32
Dies, Ventilator	54	Needle, Pearl & Bead Sewing	101	Spring End Former	32
Durable Snap Setter	60	Needle, Pearl & Bead Stringing	101	Spring Puller Hook	28
Eyelet Setter	87	Needle, Sailmaker's	102	Spring Metal Washer	46
Fastener, Turn Button & Curtain	61	Needle, Serpentine	99	Staple Knocker	18
Foam Cutter, U-Cut	22	Needle, Smyrna	101	Staple Lifters	18-19
Former, Wire	30	Needle, Spring Eye Straight Pack	102	Staple Puller Plier	17
Glue Sticks	38	Needle, Straight Pack	102	Staple Removers	18-19
Grommets and Washers	56-57	Needle, Straight Single	100	Stretcher, Level Spring	27
Grommet Die, Inserting	55	Needle, Straight Double	100	Stretcher, Plastic	26
Grommet Die, Midget	57	Needle, Straight Single 3 Sq. Pt.	100	Stretcher, Blind Seam Stitching	22
Grommet Hole Cutter	55	Needle, Straight Double 3 Sq. Pt.	100	Stuffing Iron	22
Grommet Hole Cutter Set	55	Needles, Tapestry	101	Tacks, Blued Sterilized	16
Grommet Kits & Setter	58-59	Needle, Tufting	51	Tackite	4
Groove Staple Remover	19	Needle, Weaving	99	Thimbles	93
Glides, Chair	29	Nippers, Diagonal Cutting	73	T-Nuts	29
Glides, Rubber	29	Nippers, End Cutting	73	Tucking Tool	74
Grommet Machines	40-41	Nylon Super Hook	49	Tuffer, Button Mattress	52
Hammer, Bronze Magnetic Head	8	Nylon Tufting Twine	53	Tufting Tool	51
Hammer, Dead Blow	78	Palms, Sail and Sewing	93	Upholstery Kits	33-34
Hammer, Glazier & Picture Frame	11	Picture Frame Hammer	11	Ventilators	65
Hammer, Magnetic Tack	9, 11	Pincers	73	Ventilator, Hand Setter	65
Hammer, Nylon Tip	8, 15	Pinch Dogs	38	Ventilator Dies	54, 65
Hammer, Rawhide	78	Pins, Glass Head	104	Ventilator Punch	65
Hammer, Riveting	11	Pins, Straight	103	Webbing Stretchers	26-27
Hammer, Split Head	78	Pins, "T"	103	Wire Bender	30
Hammer, Claw Tack	10	Pins, Upholstery	103	Wire Connectors	32
Handles Replacement	8, 11	Piping Tins	22	Wire Eyes	45
Hook, Spring "T" Handle	28	Pivots Buttons	48	Zipper Jig	37
Hog Rings	70	Pliers, BW	31	Zipper Stops & Tools	37
Hog Ring Pliers	70-72	Pliers, Canvas	24		

# PRODUCT INDEX: NUMERICAL

OSBORNE No.	PAGE No.	OSBORNE No.	PAGE No.	OSBORNE No.	PAGE No.	OSBORNE No.	PAGE No.	OSBORNE No.	PAGE No.	OSBORNE No.	PAGE No.
A1	57	WDISN41	54	123 1/2	20	270-8	69	519	99	1013	37
B1	56	WDISP0	54	124	18	277 1/2	9	520	53	1014	37
B1S	59	WDIVC1	54	124-12	18	297	28	521-40MM	98	1020	76
B-1 BOOK	33	W8BLT	68	129	21	302	22	522	31	1021	76
B2	56	W20	66	140	91	306 1/2	53	523	99	1035	10
B-4	33	W30	67	140-32	91	339	36	524	99	1035M	10
B-7	34	W20LH	66	140-A	92	353	81	527	53	1035-36 ST	11
B-11	34	W20P	66	140-H	91	354	81	528	53	1035-36 STK	11
DB1, DB1-S	25	W20W	66	141	91	355	81	553	98	1036, 1036E	10
G1	56, 57	W22N	66	142	92	357	81	554	100	1036 M	10
G1S	59	W22W	66	143	92	359	81	555	100	1036 P	10
G2	56, 57	W1225	67	144	92	391	78	556	100	1066	19
G3	57	W1226	67	144-43	92	392	80	557	100	1066 B	11
HB-1	33	1DSN	67	144-32	92	393	80	559-5	101	1066 BF	11
J-7S	68	2DAN	67	145	92	395	78	560-BP	101	1066 D	11
K-1	95	4	90	146	20	396	79	560-SP	101	1066 ST	11
K-3	95	18	90	147	85	399	74	561	101	1212	23
K-4	95	23-M	71	149	82	400	84	562	101	1440'S	70
K-5, K-6	95	23P-M	71	149MM	82	401	29	563	101	1440-SC, SO	70
K-7	95	23S-M	71	155 1-6	86	402	35	564	101	1442-1443	72
K-8	94	23T-M	71	155Tubes	86	402 1/2	36	565	101	1444SS	72
K-10	96	23TP-M	71	160	39	404	30	600	17	1570B	67
K-11	96	23TS-M	71	161	39	405	88	601	17	1700	87
K-12	96	24-24	87	164	65	406	88	602	17	1776	32
K-14	83	27N-29N	66	168	87	407	88	603	84	1860-1	69
K14MM	83	31	92	169	87	408	52	604-S	90	1890-1	69
K-15	96	32	92	170	87	409	98	613	51	1963	32
K-16	83	33, 33-H	8	178	104	410	22	614	51	2000	38
K-89	38	36, 36-T	8	181	104	410-B	22	615	52	2003	38
K-156	84	38N	67	183	104	412	22	621	65	2360T-M	71
K-157	84	39	8	189	103	413	91	622	65	2360TP-M	71
K229	60	40	92	190	103	414	52	631	9	2360TS-M	71
K230	60	40M-18	22	190S	103	417	51	678	29	3377	73
K231	58	42	92	193	103	417-L	51	679	29	4000	61
K232	59	43	92	196	78	418	51	680 all patterns	12-14	4020	62
K233	58	44	92	197	79	419	52	689	16	4030	62
K234	58	45	92	198	103	420	76	708	65	4100	61
K235	59	46	92	199	104	423, 423 L	88	710	19	4130	62
K-245	83	47	92	200	18	424-B	88	720	32	4140	62
K245 L	83	48	92	201	19	424-S	88	727	89	4150	62
K257-00	59	49	92	202	20	443	87	727A	89	4450-3	31
K4500	62	50-H	92	205	27	445-3	31	741	97	4451	31
K-500	55	52	92	215	55	456	87	745	74	4452	31
K-752	75	54	92	216	55	464	89	746	74	4500-PC	62
K4010	61	56	92	217	55	465	89	747	74	4500-SP	62
K4708	63	57	92	222	9	478	90	757	75	4500-UT	62
K4713	63	57-all sizes	11	222-S	9	479	77	758	75	4700-T-1/2	53
K4717	63	58	92	223	86	496	79	760	75	4700-T2	53
K6708	63	59	92	223Tubes	86	493-10	69	761 A	21	4702-214	30
K7250	68	60SE	39	229	60	498-10	69	761 B	21	4705	53
K7280	68	72	77	230	60	498-12	69	761 HL	21	4712	64
K7300	68	76, 76 1/2	77	235	57	500	55	761 HN	21	4802	16
N1	56	77	77	236	9	501	97	761 P	21	5900	29
N1S	59	78, 78 1/2	77	237	9	501 1/2	97	761/1	20	6750	15
N2	56	79 1/2	77	238	9	501X	97	761PH/1/2	35	6750-B	15
N3	57	85	38	239	28	502	97	761W 1/2	35	6750-M	15
Needle Chart	94	87	29	245	85	502-1/2	97	761W 3/4	35	6750-SB	15
RS1N	67	88	38	245MM	85	502X	97	762 P	36	6860-6893	13-14
SS	56	89	38	249	24	503	98	763	19	6910-6941	12-15
SS1-S	59	89SS 1-3/4	38	250	24	504	100	764	68	6950-6998	12-15
T-10	90	89.5	79	251	24	505	100	773-HRP	72	7000-7004	12-15
T-11	90	90	79	252	27	506	100	773-K	72	7100-7180	12-15
TC1	68	91	73	253	26	507	100	777	16	7200	32
TC5	68	92-1/2	99	255	26	508	102	786	19	7020-7256	12-15
V-1 1, V-1 3/4	65	93	73	257	87	508-1/2	102	787 A	19	7260-7266	12-15
W-1	40	94	73	258	30	508-1/2 SE	102	802	39	52247	99
W-2	40	97	75	262	36	509	102	869 B	26	52248	99
W-3	41	98, 98-S	25	263	27	510	93	869 P	26		
W-4	41	99	75	264	28	511	93	911-PK	90		
W-50	58	103 1/2	25	265	93	513	97	915	47		
WDIGRC	54	111	9	266	93	514	100	925	76		
WDIHUC	43	120	18	267	22	515	102	925-D	76		
WDIRI21	54	120 1/2	18	268	27	516	102	925-100	76		
WDISGRC	54	121	18	269	28	517	101	928	92		
WDISN201	54	122	20	270-7	69	518	101	1012	37		

# MASSASOIT/TACKBAND

Division of C.S. Osborne & Co.

The ORIGINAL manufacturer of Tack Strip, Flex Grip, Curve Ease and Nail Trim.

## TACKTITE

Punched from cold-rolled steel, our tack strip has conditioned edges and rounded ends to prevent any rips or snags on the most delicate fabrics. Tacks have serrated edges for holding power and are available in different sizes, lengths and finishes based upon the specific application. Our Tacktite with vinyl sleeve completely covers all edges of the tack strip. Vinyl sleeves also available separately.

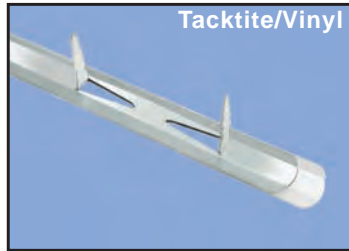

TACK STRIP		
<b>Tack Size:</b>	6 oz., 8 oz., 10 oz., 12 oz. & 20 oz. (M-Tack for Plywood)	<b>ALL COMBINATIONS AVAILABLE</b>
<b>Overall Length:</b>	Pre-cut pieces form 2" - 54"	
<b>Finishes:</b>	Plain, Vinyl Sleeve, Foam Padding, End Cut & Folded Cut	

## FLEX GRIP & CURVE EASE

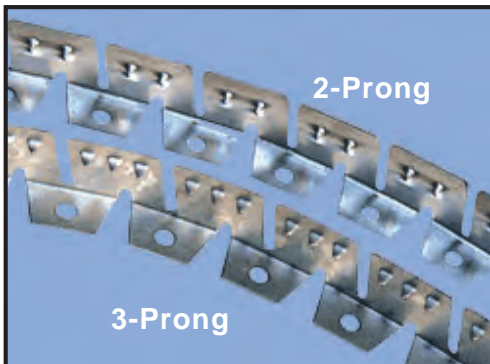

Available in 3 thicknesses: light, medium or heavy with 2 prong or 3 prong. Packed and sold in cartons of 500 ft. (five pancake rolls). Also available with foam backing. Inquire within.

FLEX GRIP & CURVE EASE	
<b># Of Prongs:</b>	2 or 3 prong
<b>Gauge:</b>	Light, Medium and Heavy
<b>Package:</b>	Carton of 500 ft. (five 100 ft. pancake rolls)



**ROLLS OF NAIL TRIM WITH MATCHING NAILS**

Eliminate the need for individual decorative nails by using nail trim to reduce time required for nail installation by 60%-80%. Nail trim comes with individual decorative nails that match the plated finish of the trim which is sized and spaced to produce a professional, uniform appearance.

NAIL TRIM WITH MATCHING NAILS	
<b>Finishes:</b>	Nickel, French Natural, Pewter.
<b>Nail Spacing:</b>	Every 2nd hole, Every 3rd hole, Every 5th hole, No Holes.
<b>Length:</b>	Available in 10 yard & 50 yard rolls with matching nails.

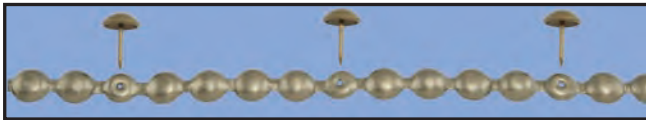

**PREMIUM UPHOLSTERY SUPPLIES**



Cardboard Tack Strip



Fiber Tack with Nails



Upholstery Springs



Italian Spring Twine



Paper Covered Stake Wire



Decorative Nails



Zig Zags Springs



Jute Webbing



Pirelli Webbing

For pricing and more product information please contact Massasoit.

**MASSASOIT/TACKBAND**

118 Dulong Circle. Chicopee, MA 01022

Phone # 413-593-6731 Fax # 413-593-3786

Email: [tackband@verizon.net](mailto:tackband@verizon.net) [www.tackband.com](http://www.tackband.com)



# LOXX<sup>®</sup> USA

C.S. Osborne & Co.



**The Strongest, Most Versatile, Self-Locking, Quick Release Fasteners Ever Made!**

**Will never accidentally open. Will never rust. Precision Engineered. Withstands shearing force greater than 1,000 N.**

**THE APPLICATIONS ARE UNLIMITED!**



**Do It Yourself**

- Bags & Pouches
- Protective Cases
- Key Chains
- Artisan Crafts
- Haberdashery
- Fashion Articles

**Marine**

- Canvas Covers
- Spray Hoods
- Sail Covers
- Map Pockets
- Cushion Fasteners
- Canopies

**Auto, RV & Golf Carts**

- Auto Tops
- Tonneau Covers
- Classic Cars
- Golf Cart Covers
- Carpet Systems
- Floor Mats
- Fire Containment

**Leather**

- Hand Bags
- Leather Cases
- Guitar Straps
- Biker Bags
- Utility Belts
- Luggage/Suitcase
- Holsters & Slings

**Enclosures**

- Rain Shields
- Storage Solutions
- Storage Nets
- Upholstery Projects
- Curtains installations
- Upholstery Covers
- Fabric attachments

- MATERIAL:** Available in high-grade brass and stainless steel.
- FINISHES:** Stainless, Nickel, Chrome, Antique Brass & Copper, Black, Brass, etc.
- STYLES:** Large Head, Small Head, Smooth Head, Pull Handle, Knurled, etc.
- ATTACHMENTS:** Compatible Screw Studs, Base Plates, Pipe Clamps, Rivet Studs, etc.
- CUSTOM:** Die Cast Heads, Private Logos & Brands, Ornamental Designs, Your Artwork, etc.



For more detailed information please visit us at:  
[www.loxxfastenersUSA.com](http://www.loxxfastenersUSA.com)



*Established  
1826*

**THE GOLD MEDALS AWARDED TO C.S. OSBORNE  
SYMBOLIZE THE PRIDE TAKEN IN OUR TOOLS BY EIGHT  
GENERATIONS OF THE OSBORNE FAMILY**





Osborne brass hammers have an inserted magnet with a steel cap in the small end and a larger steel cap on the other end. These caps are attached by a special soldering method to hold strong and true for industrial use.

## 7 OZ. HEAD BRONZE MAGNETIC HAMMER

### Osborne No. 33



Solid head of bright bronze. Steel tipped at one end for permanent magnet and at the other for hammering. Balanced design, lacquered hickory handle. Replacement handles are also available **Osborne No. 33-H** UPC No. 56046.

Length of head (inches)	Weight of head (oz)	Magnetic face (inches)	Large face (inches)	Weight ea (oz)	UPC No.
5 1/2	7	1/4	7/16	11	56042

## 9 OZ. HEAD BRONZE MAGNETIC HAMMER

### Osborne No. 39



This hammer is similar to our popular No. 33 magnetic hammer but a heavier version. Lacquered hickory handle. Replacement handles are also available **Osborne No. 33-H** UPC No. 56046.

Length of head (inches)	Weight of head (oz)	Magnetic face (inches)	Large face (inches)	Weight ea (oz)	UPC No.
5 1/2	9	5/16	7/16	13	56052

## NYLON TIP MAGNETIC HAMMER

### Osborne No. 36

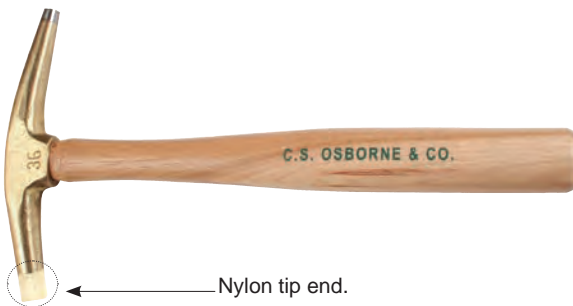

This hammer is similar to our popular No. 33 magnetic hammer but the large face is fitted with a nylon tip and the other end has an inserted magnet. Used where a soft strike is needed. Lacquered hickory handle. Replacement handles are also available **Osborne No. 33-H** UPC No. 56046.

Length of head (inches)	Weight of head (oz)	Magnetic face (inches)	Large face (inches)	Weight ea (oz)	UPC No.
5 1/2	6	1/4	7/16	11	56072

← Nylon tip end.

Nylon tips also available separately. **Part No. 36-T** UPC No. 56076

## REPLACEMENT HANDLES

### Osborne No. 33-H



Lacquered hickory replacement handles for above hammers. Includes wedge. UPC No. 56046.



Osborne magnetic hammers will give long service if properly used and stored. The magnetic end should be used only for setting a tack in place. The striking end is for driving tacks home. The magnetic head should never be left in contact with other steel objects. Should one of our hammers lose its magnetism, we will re-magnetize free of charge if it is sent prepaid to the factory.

## MAGNETIC TACK HAMMER BALANCED

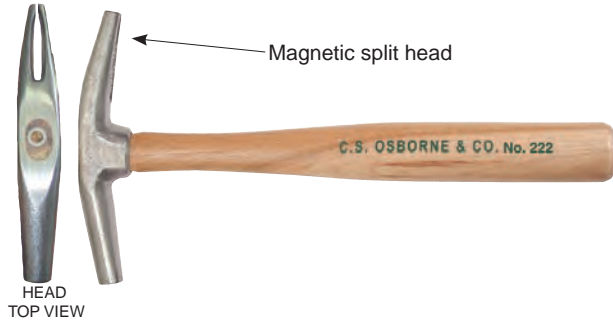

### Osborne No. 222

Forged steel. Fully polished split head. Lacquered hickory handle. A versatile magnetic hammer. Made to U.S. Government specifications.

Length of head (inches)	Weight of head (oz)	Magnetic face (inches)	Large face (inches)	Weight ea (oz)	UPC No.
5 1/2	7	5/16	9/16	13	56012

### Osborne No. 222-S

This hammer is the same as the No. 222 except it has an extra small 1/4" face. If this small size is wanted, specify No. 222-S. All other dimensions are the same. UPC No. 56018.

## LIGHT WEIGHT UPHOLSTERS' HAMMER

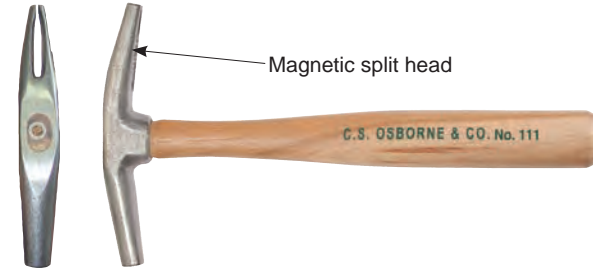

### Osborne No. 111

Forged steel. Similar to our Osborne No. 222 but with a lighter weight head.

Length of head (inches)	Weight of head (oz)	Magnetic face (inches)	Large face (inches)	Weight ea. (oz)	UPC No.
5 1/4	6	5/16	9/16	7	56022

## MAGNETIC TACK HAMMERS - Short head

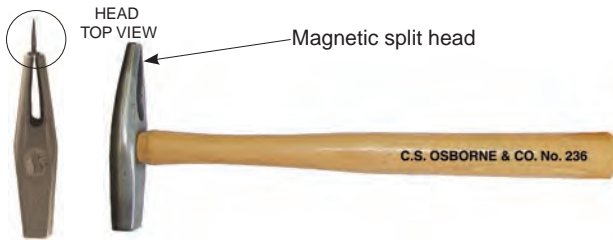

Popular weights and sizes for window trimmers, upholsters and house hold use. Forged from our special tool steel, carefully tempered. Fully polished head. Lacquered hickory handle.

Osborne No.	Length of head (in)	Weight of head (oz)	Magnetic face (in)	Overall length (in)	Weight ea (oz)	UPC No.
236	3 1/2	4	1/4	11	6	56032
237	4 1/8	5	1/4	11	7	56034
238	4 3/8	7	5/16	10 1/2	11	56036

## MAGNETIC NAIL & TACK PLACER



### Osborne No. 631

The 5/8" octagon shank is made of stainless steel with a powerful permanent alnico magnet inserted in the tip. Can be used to set nails and tacks in a tight place. 2 sizes available.

Osborne No.	Overall (inches)	Weight ea. (oz)	UPC No.
631 5-1/2	5 1/2	13	64422
631 8	8	22	64424

## RIPPING HAMMER



### Osborne No. 277 1/2

Forged steel, balanced and tough. Double edged at right angles for stripping off old fabric. A favorite with upholsters.

Overall (inches)	Length of head (inches)	Width of bits (inches)	Weight ea. (oz)	UPC No.
10 1/4	5	13/16	13	56162



## CLAW TACK HAMMER

### Osborne No. 1035

Original upholsterer's hammer. Forged steel head hardened and polished. Hickory lacquered hardwood handle. Round shaped head. Hammer has spring stabilizers. 2 sizes available.

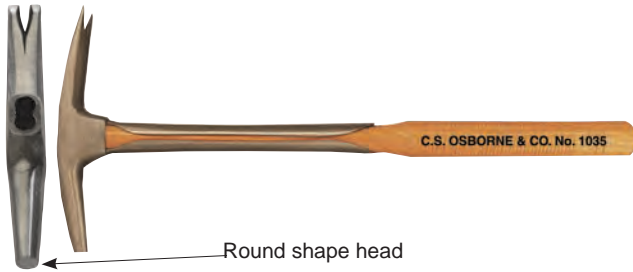

Round shape head

Size	Length of head (inches)	Weight of head (oz)	Magnetic face (inches)	Overall length (inches)	Weight ea (oz)	UPC No.
8	5-1/2	11	5/16	12	13	70006
10	5-1/2	12	7/16	12	14	70000

## MAGNETIC TACK HAMMER

### Osborne No. 1035 M

Same as above but **with magnetic split round head**. Available in 3 different sizes.

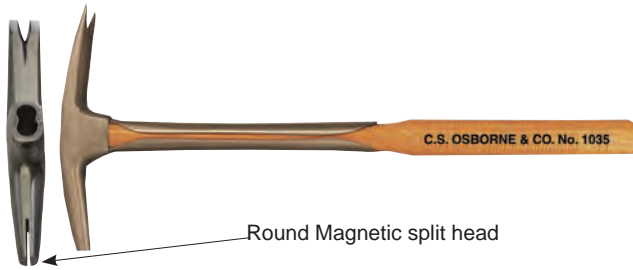

Round Magnetic split head

Size	Length of head (inches)	Weight of head (oz)	Magnetic face (inches)	Overall length (inches)	Weight ea (oz)	UPC No.
M8	5 1/2	11	5/16	12	13	64532
M9	5 1/2	11	3/8	12	14	64546
M10	5 1/2	12	7/16	12	14	64530

## TACK HAMMER

### Osborne No. 1036

Similar to our Osborne No. 1035 but with a shorter head and lighter weight. Upholstery hammer with spring stabilizers. Hardwood lacquered handle. Forged steel head hardened and polished. 4 sizes available.

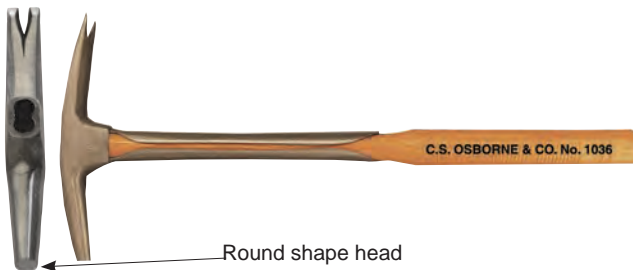

Round shape head

Size	Length of head (inches)	Weight of head (oz.)	Magnetic face (inches)	Overall length (inches)	Weight ea. (oz.)	UPC No.
10	4 1/2	4	3/8	12	8	70020
12	4 1/2	4	7/16	12	8	70024
13	4 1/2	5	1/2	12	8	70026
14	4 1/2	5	9/16	12	9	70028

## MAGNETIC TACK HAMMER

### Osborne No. 1036 M

Same as above but **with magnetic split round head**. Available in 2 different sizes.

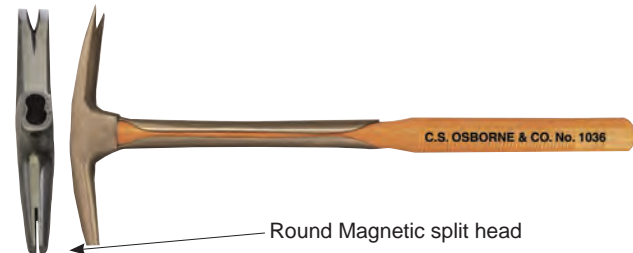

Round Magnetic split head

Size	Length of head (inches)	Weight of head (oz.)	Magnetic face (inches)	Overall length (inches)	Weight ea. (oz.)	UPC No.
M10	4 1/2	11	3/8	12	8	70010
M12	4 1/2	12	7/16	12	8	70014

## NYLON TIP TACK HAMMER

### Osborne No. 1036 P

Forged steel head hardened and polished. Hickory lacquered hardwood handle. Round shaped end. It also has spring stabilizers. 2 sizes available.



Nylon tip end.

Size	Length of head (inches)	Weight of head (oz)	Magnetic face (inches)	Overall length (inches)	Weight ea (oz)	UPC No.
12	4-1/2	13	7/16	12	14	70032
14	4-1/2	14	1/2	12	14	70034

Replaceable nylon tips are also available **Osborne No. 1036E-12** or **Osborne No. 1036E-14**. Specify size when ordering.



## GLAZIER & PICTURE FRAMING HAMMERS

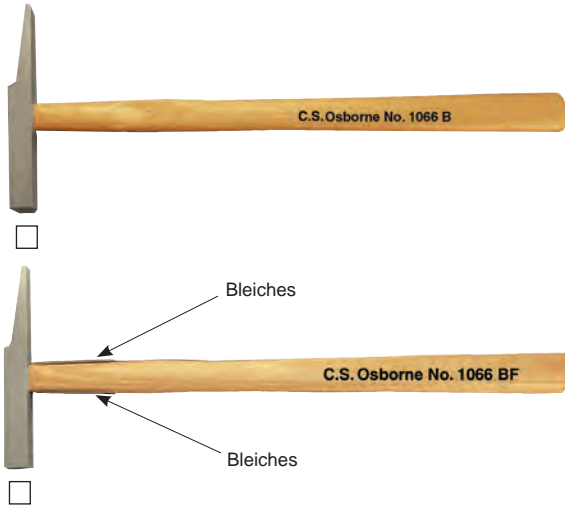

### Osborne No. 1066 B

Hardwood handle. Forged steel head fully polished. An industry standard. Accurately finished straight sides and square face for striking.

Overall of head (inches)	Face diameter (inches)	Overall length (inches)	Weight ea. (oz.)	UPC No.
4-1/4	11/16	12	6	70042

### Osborne No. 1066 BF

Same as above glazier hammer, but with stabilized spring handle (bleiches). UPC No. 70044.

## MAGNETIC TACK HAMMER (Split head)

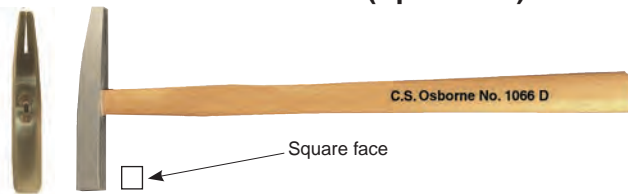

### Osborne No. 1066 D

Magnetic tack hammer with hardwood handle. Forged steel head hardened and polished with inserted magnet.

Length of head (inches)	Weight of head (oz.)	Diameter of face (in)	Overall length (in)	Weight ea. (oz.)	UPC No.
4-1/4	4	11/16	12	6	70046

## RIVETING HAMMER



### Osborne No. 57

Forged steel highly polished head. Hardwood handle. Different sizes available.

Size No.	Length of head (inches)	Diameter of face (inches)	Weight of head (oz)	Weight each (oz)	UPC No.
000	3	3/8	2 1/2	4	56082
00	3 3/8	3/8	3	4	56084
0	3 5/8	7/16	4	6	56086
1	4	1/2	5	8	56088
2	4 1/4	9/16	7	12	56090
3	4 1/2	5/8	9	14	56092
4	4 3/4	3/4	12	16	56094

## REPLACEMENT HANDLES & WEDGES



### Osborne No. 1035-36 ST

Replacement hardwood handles for the 1035 and 1036 hammers.

Overall length (inches)	Diameter of handle (inches)	Weight ea. (oz)	UPC No.
12	5/8	3	70002

### Osborne No. 1035-36 STK

Replacement wedges for 1035 & 1036 hammers. UPC No. 70004.

## REPLACEMENT HANDLES



### Osborne No. 1066 ST

Replacement hardwood handles with bleiches and wedges for above hammers.

Overall length (inches)	Diameter of handle (inches)	Weight ea. (oz)	UPC No.
12	5/8	3	70048



Osborne quality steel nails with brass finish with 1/2" & 5/8" long nail. Packed 1000 pcs. per box (small sizes) and 250 pcs. per box (larger sizes). Osborne No. 680, 681, 682, 682N, 683, 684 & 6892 are also available in Poly Bags (10 bags of 100 nails each packed into a box). See page 16.

### Brass Plated

Actual Sizes	Osborne No.	Finish/Diameter	Length (in)	Nails box	UPC No.
	6920-BP 1/2	Brass Plated 1/4" diameter	1/2"	1,000	13716
	6925-BP 1/2 6925-BP 5/8	Brass Plated 7/16" diameter	1/2" 5/8"	1,000	13732 13733
	6930-BP 5/8	Brass Plated 3/4" diameter	5/8"	250	13718

### Natural

Actual Sizes	Osborne No.	Finish/Diameter	Length (in)	Nails box	UPC No.
	7250-N 1/2 7250-N 5/8	Natural 7/16" diameter	1/2" 5/8"	1,000	13802 13824
	7252-N 5/8	Natural 5/8" diameter	5/8"	250	13784
	7254-N 5/8	Natural 3/4" diameter	5/8"	250	13786
	7256-N 5/8	French Natural 1" diameter	5/8"	250	13788

### French Natural

Actual Sizes	Osborne No.	Finish/Diameter	Length (in)	Nails box	UPC No.
	681 1/2	French Natural 3/8" diameter	1/2"	1,000	14452
	682 1/2	French Natural 7/16" diameter	1/2"	1,000	14462
	6936-FN 1/2	French Natural Dark 7/16" diameter	1/2"	1,000	13784
	6938-FN 1/2	French Natural Light 7/16" diameter	1/2"	1,000	13782
	6934-FN 5/8	French Natural Low Dome 5/8" diameter	5/8"	250	13758
	6932-FN 5/8	French Natural High Dome 5/8" diameter	5/8"	250	13738
	6931-FN 5/8	French Natural 11/16" diameter	5/8"	250	13736
	6933-FN 5/8	French Natural 3/4" diameter	5/8"	250	13756
	6935-FN 5/8	French Natural 1" diameter	5/8"	250	13740

### Natural Dark

Actual Sizes	Osborne No.	Finish/Diameter	Length (in)	Nails box	UPC No.
	7260-ND 1/2 7260-ND 5/8	Natural Dark 7/16" diameter	1/2" 5/8"	1,000	13790 13827
	7262-ND 5/8	Natural Dark 5/8" diameter	5/8"	250	13792
	7264-ND 5/8	Natural Dark 3/4" diameter	5/8"	250	13794
	7266-ND 5/8	Natural Dark 1" diameter	5/8"	250	13796

### Copper Plated

Actual Size	Osborne No.	Finish/Diameter	Length (in)	Nails box	UPC No.
	6941-CP 1/2	Copper Plated 7/16" diameter	1/2"	1,000	13734
	6940-CP 1/2	Copper Plated 1/2" diameter Flat Head	1/2"	1,000	13720

Nail Diameter	1/4"	3/8"	7/16"	1/2"	5/8"	11/16"	3/4"	1"
Pcs / box	1,000	1,000	1,000	1,000	250	250	250	250
Weight / box (lbs.)	1.1	2.3	2.5	2.8	1.2	2.3	2.4	3.7



### Antique Oxidized

Actual Sizes	Osborne No.	Finish/Diameter	Length (in)	Nails box	UPC No.
	6990-AO 1/2	Antique Oxidized 7/16" diameter	1/2"	1,000	13730
	6993-AO 5/8	Antique Oxidized 5/8" diameter	5/8"	250	13744
	6992-AO 5/8	Antique Oxidized 3/4" diameter	5/8"	250	13742
	6995-AO 5/8	Antique Oxidized 1" diameter	5/8"	250	13748

### Zinc Plated Matte Pewter

Actual Sizes	Osborne No.	Finish/Diameter	Length (in)	Nails box	UPC No.
	6980-ZPM 1/2	Zinc Plated Matte Pewter 7/16" diameter	1/2"	1,000	13762
	6986-ZPM 5/8	Zinc Plated Matte Pewter 5/8" diameter	5/8"	250	13806
	6985-ZPM 5/8	Zinc Plated Matte Pewter 11/16" diameter	5/8"	250	13804
	6987-ZPM 5/8	Zinc Plated Matte Pewter 3/4" diameter	5/8"	250	13808
	6988-ZPM 5/8	Zinc Plated Matte Pewter 1" diameter	5/8"	250	13810

### Spanish Nail

Actual Sizes	Osborne No.	Finish/Diameter	Length (in)	Nails box	UPC No.
	6890-SN 1/2	Spanish Nail 3/16" diameter	1/2"	1,000	13710
	6892-SN 1/2	Spanish Nail 7/16" diameter	1/2"	1,000	13700
	685-SN 5/8	Spanish Nail 5/8" diameter	5/8"	250	14497
	6891-SN 5/8	Spanish Nail 3/4" diameter	5/8"	250	13728
	6893-SN 5/8	Spanish Nail 1" diameter	5/8"	250	13818

### Nickel Plated

Actual Sizes	Osborne No.	Finish/Diameter	Length (in)	Nails box	UPC No.
	6948-NP 1/2	Nickel Plated 1/4" diameter	1/2"	1,000	13822
	6950-NP 1/2	Nickel Plated 5/16" diameter	1/2"	1,000	13722
	682N 1/2	Nickel Plated 7/16" diameter	5/8"	1,000	14472
	6960-NP 1/2	Nickel Plated 1/2" diameter	5/8"	1,000	13724
	6962-NP 5/8	Nickel Plated 5/8" diameter	5/8"	250	13840
	6963-NP 5/8	Nickel Plated 3/4" diameter	5/8"	250	13842
	6965-NP 5/8	Nickel Plated 1" diameter	1"	250	13798

### Old Copper Ground

Actual Size	Osborne No.	Finish/Diameter	Length (in)	Nails box	UPC No.
	7180-OCG 1/2	Old Copper Ground 7/16" diameter	1/2"	1,000	13800

### Super Tack

Actual Size	Osborne No.	Finish/Diameter	Length (in)	Nails box	UPC No.
	7020-ST 5/8	Super tack 3/4" diameter	5/8"	250	13820

	ACTUAL SIZE	6901-NP 1/2	Oxford Nickel Plated 7/16" diameter	1/2"	1,000	13726
--	-------------	-------------	-------------------------------------	------	-------	-------



### Old Gold Speckled

Actual Sizes	Osborne No.	Finish/Diameter	Length (in)	Nails box	UPC No.
	7110-OGS 1/2	Old Gold Speckled 7/16" diameter	1/2"	1,000	13766
	7111-OGS 1/2	Old Gold Speckled 5/8" diameter	5/8"	250	13768
	7112-OGS 5/8	Old Gold Speckled 3/4" diameter	5/8"	250	13770

### Old Copper Lacquer Rolled

Actual Sizes	Osborne No.	Finish/Diameter	Length (in)	Nails box	UPC No.
	7000-OCLR 1/2	Old Copper Lac. Rolled - Orient 7/16" diameter	1/2"	1,000	13748
	7001-OCLR 1/2	Old Copper Lac. Rolled - Daisy 7/16" diameter	1/2"	1,000	13750
	7002-OCLR 1/2	Old Copper Lac. Rolled - Overlap 7/16" diameter	1/2"	1,000	13780
	7003-OCLR 1/2	Old Copper Lac. Rolled - Oxford 7/16" diameter	1/2"	1,000	13752
	7003-OCLR 5/8		5/8"		13836

### Old Gold Speckled Red

Actual Sizes	Osborne No.	Finish/Diameter	Length (in)	Nails box	UPC No.
	6880-OGSR 1/2	Old Gold Speckled Red 3/8" diameter	1/2"		13708
	6884-OSGR 1/2	Old Gold Speckled Red 7/16" diameter	1/2"	1,000	13790
	6881-OGSR 5/8	Old Gold Speckled Red 5/8" diameter	5/8"	250	13776
	6882-OGSR 5/8	Old Gold Speckled Red 3/4" diameter	5/8"	250	13778

### Bronze Lacquered Rolled

	6970-BRLR 1/2	Bronze Renaissance Lac. Rolled - Orient 7/16" diameter	1/2"	1,000	13760
	683 1/2	Bronze Lac. Rolled - Daisy 7/16" diameter	1/2"	1,000	14482
	684 1/2	Bronze Lac. Rolled - Overlap 7/16" diameter	1/2"	1,000	14492
	680 1/2	Bronze Lac. Rolled - Oxford 7/16" diameter	1/2"	1,000	14442

### Old Gold Dark

Actual Sizes	Osborne No.	Finish/Diameter	Length (in)	Nails box	UPC No.
	6870-OGSD 1/2	Old Gold Speckled Dark 7/16" diameter	1/2"	1,000	13706
	6871-OGSD 5/8	Old Gold Speckled Dark 5/8" diameter	5/8"	250	13772
	6872-OGSD 5/8	Old Gold Speckled Dark 3/4" diameter	5/8"	250	13774

Actual Sizes	Osborne No.	Finish/Diameter	Length (in)	Nails box	UPC No.
	6910-BL 1/2	Honey Comb Lac. Rolled Bronze 7/16"	1/2"	1,000	13714
	7210-OSLR 1/2	Honey Comb Lac. Rolled Old Silver 7/16"	1/2"	1,000	13792
	7004-OCLR 1/2	Honey Comb Lac. Rolled Old Copper 1/2"	1/2"	1,000	13754



Actual Sizes	Osborne No.	Finish/Diameter	Length (in)	Nails box	UPC No.
	7140-BN 1/2	Black Niquel 7/16" diameter	1/2"	1,000	13796
	7100-BLM 1/2	Black Lacquered Matte 7/16" diameter	1/2"	1,000	13764
	7100-BLM 5/8		5/8"		13828
	7160-BL 1/2	Black Lacquered Glossy 7/16" diameter	1/2"	1,000	13798

### Old Brass Speckled



Actual Size	Osborne No.	Finish/Diameter	Length (in)	Nails box	UPC No.
	6860-OBS 1/2	Old Brass Speckled 7/16" diameter	1/2"	1,000	13704

	6998-AO 1/2	Antique Oxidized Light 7/16"	1/2"	1,000	13751
	6996-AO 1/2	Antique Oxidized Dark 7/16"	1/2"	1,000	13749

### Pewter Light

Actual Sizes	Osborne No.	Finish/Diameter	Length (in)	Nails box	UPC No.
	6954-PL 1/2 6956-PL 5/8	Pewter light 7/16" diameter	1/2" 5/8"	1,000 250	13844 13846
	6958-PL 5/8	Pewer light 5/8" diameter	5/8"	250	13848

### Pewter Dark

Actual Sizes	Osborne No.	Finish/Diameter	Length (in)	Nails box	UPC No.
	6974-PD 1/2 6976-PD 5/8	Pewter dark 7/16" diameter	1/2" 5/8"	1,000 250	13850 13852
	6978-PD 5/8	Pewter dark 5/8" diameter	5/8"	250	13854

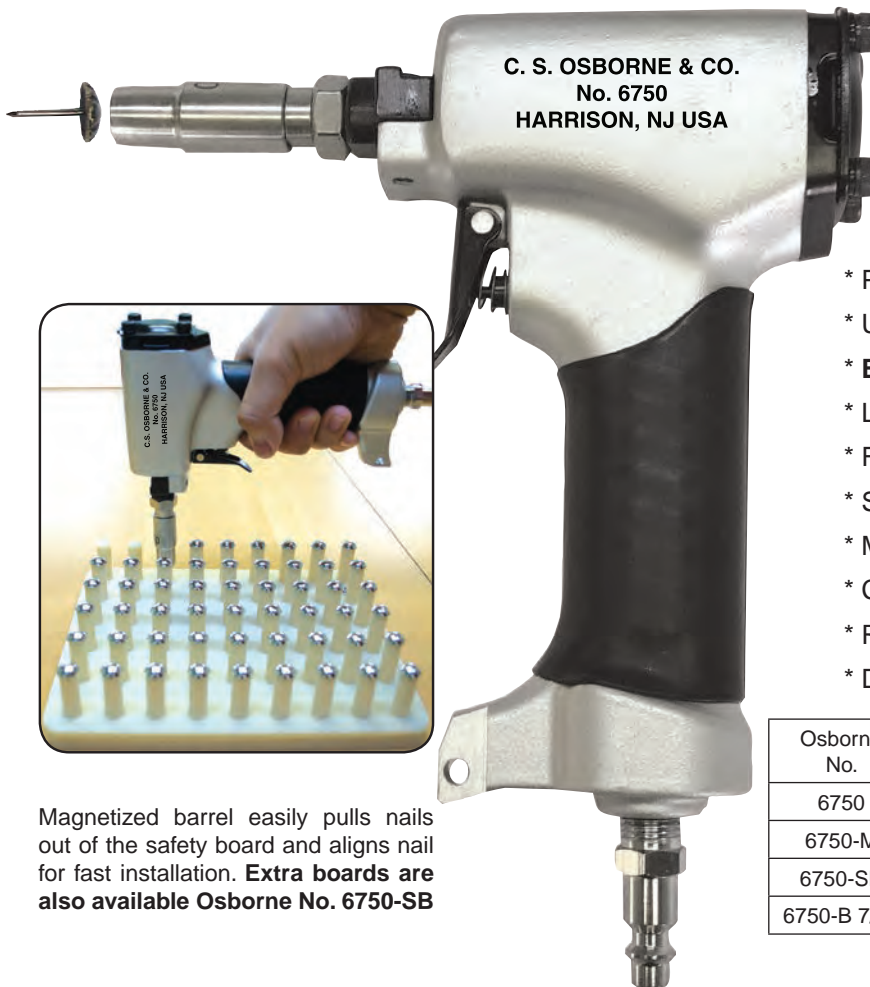

## SINGLE SHOT NAILER

### Osborne No. 6750

- \* Professional grade. Saves time and money.
- \* Use with 7/16" diameter nails.
- \* **EXTRA** 5/8" and 3/4" barrels also available.
- \* Light weight ergonomic design. 1 lb. 6 oz.
- \* Fast, easy and affordable.
- \* Single nail design will never jam the tool.
- \* Magnetized barrel loads nails effortlessly.
- \* Comes with safety nail loading board.
- \* Recommended air pressure 70-110 PSI.
- \* Decorative Nail display board also available.

Magnetized barrel easily pulls nails out of the safety board and aligns nail for fast installation. **Extra boards are also available Osborne No. 6750-SB**

Osborne No.	Description	Weight each (oz.)	UPC No.
6750	Pneumatic Nailer	22	76295
6750-M	Magnet for Nailer	2	13864
6750-SB	Safety board	10	76290
6750-B 7/16	7/16" Barrel	2	76296

## LARGE BARRELS FOR PNEUMATIC NAILER



### Osborne No. 6750-B

Sold separately when you need to install 3/4" head diameter nails or with 5/8" diameter.

Osborne No.	Description	Weight each (oz.)	UPC No.
6750-B 5/8	Barrel for 5/8" decorative nail	4	76295
6750-B 3/4	Barrel for 3/4" decorative nail	4	76294





## POLY BAGS



Decorative Nails Osborne No. 680, 681, 682, 682N, 683, 684 & 6892 are also available in Poly Bags (10 bags of 100 nails each, packed into a box). Sold by box only, not individual bags.

Osborne No.	Description	Weight/box	UPC No.
680S 1/2	10 poly bags of Oxford Hammered Nail 1/2" tack	3 lbs.	14447
681S 1/2	10 poly bags of French Natural Nail 1/2" tack - Small	3 lbs.	14457
682S 1/2	10 poly bags of French Natural Nail 1/2" tack	3 lbs.	14467
682NS 1/2	10 poly bags of Nickel Plated Nail 1/2" tack	3 lbs.	14477
683S 1/2	10 poly bags of Daisy Nails 7/16" diam - 1/2" tack	3 lbs.	14487
684S 1/2	10 poly bags of Overlap Nails 7/16" - 1/2" tack	3 lbs.	14495
6892NS 1/2	10 poly bags of Spanish Nails 7/16" diam. 1/2" tack	3 lbs.	13700

## QUICK NAILER



### Osborne No. 777

Patent No. 4079764

#### FANCY NAIL SPACER FOR SPACING ANTIQUE NAILS.

Set up to 5 nails head to head at one time without damaging the furniture, or your fingers. Exact spacing at the same time! Load large end of tool making sure nails are perpendicular to and shanks are flush with base of tool. Position tunneled section of tool over last nail driven and begin setting nails. Removal of tool may require twisting motion and/or pressure against nail heads with free hand. Use Osborne No. 36 Nylon tip hammer for best results. 6" long. 3 oz. UPC No. 64502.

## NYLON TIP MAGNETIC HAMMER



### Osborne No. 36

The large face is fitted with a nylon tip to avoid damage to the decorative nails. The other end has an inserted magnet. Used where a soft strike is needed. Lacquered hickory handle. Replacement handles are also available **Osborne No. 33-H** UPC No. 56046. Nylon tips also available separately. **Part No. 36-T** UPC No. 56076

Length of head (inches)	Weight of head (oz)	Magnetic face (inches)	Large face (inches)	Weight ea (oz)	UPC No.
5 1/2	6	1/4	7/16	11	56072

## PLASTIC NAIL STRIP



### Osborne No. 4802

Used to align the decorative nails, giving the same space between. Works only with the 3/8" diameter decorative nails. Packed and sold 100 strips to a bag.

Amount of nails per strip	Amount of strips per bag	Weight / bag (oz)	UPC No.
100	100	4	78330

## BLUED STERILIZED TACKS



Corrugated tacks also available.

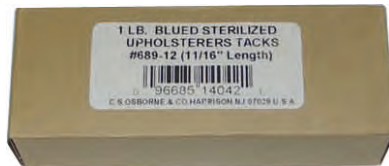

Osborne No. 689C-12

### Osborne No. 689

Sharp points and strong, thin oval heads are ideal for attaching all types of webbing, fabric and leather. Sturdy construction and blued finish to protect against rusting. Sterilized by radiation. Sold in 1 lb. boxes. Available in 4 sizes.

Osborne No.	Description	Weight/box	UPC No.
689-3	3/8" Length - Blued sterilized tacks	1 lb.	14038
689-6	1/2" Length - Blued sterilized tacks	1 lb.	14040
689-12	11/16" Length - Blued sterilized tacks	1 lb.	14042
689-12C	11/16" Length - Same but corrugated	1 lb.	14044

## DECORATIVE NAIL PLIER REMOVER



### Osborne No. 601

Hardened steel, top quality. Very convenient size for removing decorative nails. Unique design. The leg gives leverage which makes the nail easy to pull out.

Overall length (inches)	Width (inches)	Weight ea (oz)	UPC No.
7	1 3/4	6	54212

## STAPLE PULLER PLIER



### Osborne No. 600

Forged steel. Vinyl handles to add comfort. Nose of the plier is bent at the right angle to go under the staple, grab it and pull it out.



Overall length (inches)	Maximum head opening (inches)	Weight ea. (oz)	UPC No.
6 1/2	7/8	6	54216

## STAPLE PULLER PLIER



### Osborne No. 602

Forged steel. Blued finished. Vinyl handles to add comfort and prevent from slipping. Opening spring. The uniquely design welded pin gives leverage when pulling out the staples and is plastic coated to prevent any damage to furniture. Sharp points with a hook design overlap when closed to pull staples out with ease.

Overall length (inches)	Maximum head opening (inches)	Weight ea. (oz)	UPC No.
8	3/4	9	54214

Sharp points with hook design overlap when closed.



## STAPLE LIFTER



Working end

### Osborne No. 120 1/2

The correct angle for removing staples of any size, from the smallest to the longest leg staples. Manufactured from alloy tempered steel. Electronically hardened working ends. Fluted amber cellulose acetate handle to keep from rolling.

Length of blade (inches)	Overall length (inches)	Weight each (oz.)	UPC No.
4 1/2	8 1/2	4	64006

## STAPLE KNOCKER

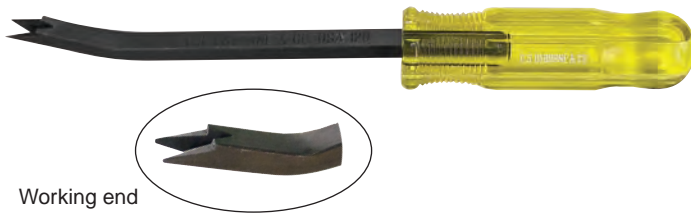

Working end

### Osborne No. 120

Staple knocker for removing staples and shredded material. Manufactured from top grade steel. Electronically hardened working ends. Fluted amber cellulose acetate handle to keep from rolling. Use with Osborne hickory or rawhide mallets.

Length of blade (inches)	Overall length (inches)	Weight each (oz.)	UPC No.
4 1/2	8 1/2	4	64004

## STAPLE REMOVER



### Osborne No. 124

Forged from alloy tempered steel. A consistently made Osborne quality product. Carefully hardened for long lasting use. Hardwood handle with nickel plated ferrule.

Length of blade (inches)	Overall length (inches)	Weight each (oz.)	UPC No.
2 1/4	6	4	64014

## STAPLE REMOVER



### Osborne No. 124-12

Similar to our Osborne No. 124 but with longer blade. Ideal to remove staples in hard to reach places.

Length of blade (inches)	Overall length (inches)	Weight each (oz.)	UPC No.
8 1/4	12	7	64016

## TACK & STAPLE REMOVER



### Osborne No. 121

Used for grooving out drawers, so when re-glued they will stick. Also removes staples. Made of forged steel with wooden handle and a nickel plated ferrule.

Length of blade (inches)	Overall length (inches)	Weight each (oz.)	UPC No.
2 1/2	6 1/2	2	64010

## CLAW TOOL



### Osborne No. 200

Narrow at the point to get in tight places without harming fabric or wood. Hardened and tempered end. Wooden handle with nickel plated ferrule.

Length of blade (inches)	Overall length (inches)	Weight each (oz.)	UPC No.
3 1/4	7 1/2	3	64220



## STAPLE LIFTER



### Osborne No. 763

Forged steel. Nickel plated. Fluted amber cellulose acetate handle to keep from rolling. Designed to dig down and to remove staples quickly.

Length of blade (inches)	Overall length (inches)	Weight each (oz.)	UPC No.
2 1/4	6 1/2	4	64784

## STAPLE AND TACK LIFTER

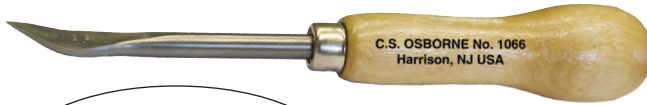

### Osborne No. 1066

Polished and forged steel blade. Hardwood handle. Nickel plated ferrule. A European favorite.

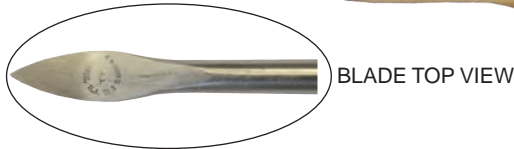

Length of blade (inches)	Overall length (inches)	Weight each (oz.)	UPC No.
3 5/8	8	3	64018

## GROOVE STAPLE REMOVER



### Osborne No. 710

Electronically hardened working end. Fluted amber cellulose acetate handle to keep from rolling. Remove welt cord from groove. Pull upholstery fabric from groove leaving staples exposed. Reach in groove with staple puller.



Length of blade (inches)	Overall length (inches)	Weight each (oz.)	UPC No.
3 7/8	7 3/4	3	64020

## STAPLE AND TACK CLAW

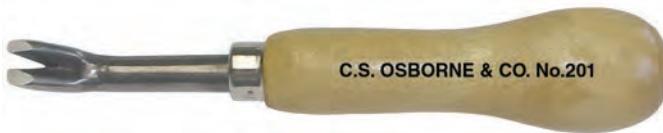

### Osborne No. 201

A quality forged tack claw. Pointed ends are hardened and tempered to prevent breakage. Wooden handle with nickel plated ferrule.

Length of blade (inches)	Overall length (inches)	Weight each (oz.)	UPC No.
2 1/2	7	4	64224

## SIDE CUTTER - STAPLE REMOVERS

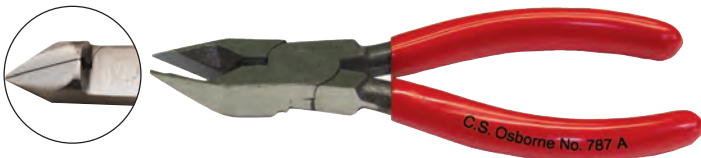

### Osborne No. 787 A

Forged steel with extra long, pointed cutter. Bevel cut. Polished head with vinyl handles. Depth of head aids in removing staples. This is the famous European "Viennese".

Bevel Cut

Osborne No.	Overall length (inches)	Angle of head (degrees)	Type of cut	Weight each (oz.)	UPC No.
787 A	6 1/2	45	Bevel	3	64806

## SMALL SIDE CUTTER

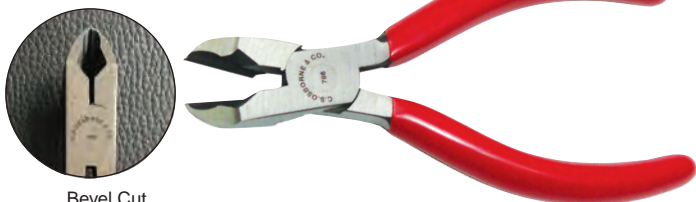

### Osborne No. 786

Forged steel. Vinyl handles to add comfort. Similar to above but smaller version. Pointed cutter. Depth of the head aids in removing staples.

Bevel Cut

Osborne No.	Overall length (inches)	Angle of head (degrees)	Type of cut	Weight each (oz.)	UPC No.
786	6 1/2	45	Bevel	3	64804

## CLAW TOOL



### Osborne No. 123 1/2

Boss claw tool. Drop forged blade with 1/2 inch diameter shank. Translucent amber cellulose acetate handle. Very sturdy.

Length of blade (inches)	Overall length (inches)	Weight each (oz)	UPC No.
2 5/8	7	6	64210

## STAPLE AND TACK CLAW



### Osborne No. 202

Sturdy forged steel cobbler's claw tool with multisided amber plastic handle. Hardened and tempered ends.

Length of blade (inches)	Overall length (inches)	Weight each (oz.)	UPC No.
2 1/2	7	4	64226

## CLAW TOOL



### Osborne No. 122

This claw is specially designed for lifting tacks and small nails. Drop forged steel blade. Hardwood handle. Nickel plated ferrule.

Length of blade (inches)	Overall length (inches)	Weight each (oz.)	UPC No.
2 7/8	7 1/4	3	64204

## CARDER TACK CLAW



### Osborne No. 146

Cold drawn 1/2 inch tempered plated steel blade. Black plastic handle. Carded on yellow background 8 1/2" x 3 1/2".

Length of blade (inches)	Overall length (inches)	Weight each (oz.)	UPC No.
3 1/4	7 1/2	3	64220



View of claw

## CLAW TOOL



### Osborne No. 761/1

The ideal tool for pulling tacks or nails. Forged steel blade, nickel plated. Hardwood pear shaped handle. Nickel plated ferrule.

Length of blade (inches)	Overall length (inches)	Weight each (oz.)	UPC No.
3 1/2	7 3/4	4	64780



## CLAW TOOL



### Osborne No. 761 A

Similar to our Osborne No. 761/1 but with longer blade.

Length of blade (inches)	Overall length (inches)	Weight each (oz.)	UPC No.
4 <sup>3</sup> / <sub>8</sub>	8 <sup>3</sup> / <sub>4</sub>	6	64769

## STAPLE AND TACK CLAW



### Osborne No. 761 B

Similar to our Osborne No. 761 A but with reinforced striking end on the handle.

Length of blade (inches)	Overall length (inches)	Weight each (oz.)	UPC No.
4 <sup>3</sup> / <sub>8</sub>	8 <sup>3</sup> / <sub>4</sub>	6	64784

## CLAW TOOL



### Osborne No. 761 P

Similar to our Osborne No. 761 A but with a cellulose acetate handle.

Length of blade (inches)	Overall length (inches)	Weight each (oz.)	UPC No.
4 <sup>3</sup> / <sub>8</sub>	8 <sup>3</sup> / <sub>4</sub>	6	64774

## FRENCH CLAW TOOL



### Osborne No. 129

The ideal tool for pulling tacks or nails. Forged steel blade, Hardwood pear shaped handle. Nickel plated ferrule.

Length of blade (inches)	Overall length (inches)	Weight each (oz.)	UPC No.
8 <sup>3</sup> / <sub>4</sub>	4 <sup>1</sup> / <sub>4</sub>	2	64228

## REPLACEMENT HANDLES

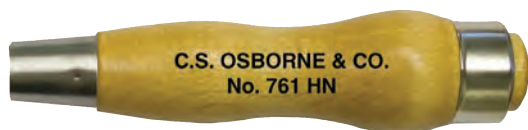

### Osborne No. 761 HN

Replacement handle for our popular Osborne No. 761 B. Hardwood with reinforced striking end.



### Osborne No. 761 HL

Replacement handle for our popular Osborne No. 761W 1/2 Ripping Chisel. Hardwood with reinforced striking end.

Osborne No.	Overall length (inches)	Weight each (oz.)	UPC No.
761 HN	4 <sup>3</sup> / <sub>4</sub>	2	64771
761 HL	5	2	64773

## U-CUT FOAM RUBBER SLICER - Patented



Special sharp blade for easy cutting

### Osborne No. 410

U-Cut is fast and flexible. Place U-Cut on a flat surface with the foam material to be cut. The desired cutting thickness is quickly set by means of an adjustable screw setting.

The operator then merely pushes and pulls the U-Cut in a saw-like action making wedges, curves, arcs and other special shapes.

U-Cut is great for proto-typing and small furniture jobs.

U-Cut will cut from a minimum thickness of 1/4" to a maximum thickness of 9". Material up to 36" in width and unlimited length can be processed. Scrap can be glued, salvage and re-cut.

Extra blades available. **OSBORNE No. 410-B** UPC No. 14354.

Overall length (inches)	Width (inches)	Weight (oz.)	UPC No.
46	17	7-1/2	14352

## BLIND STITCHING SEAM STRETCHER



INSTRUCTIONS FOR OPERATING ARE PRINTED ON PACKAGING

### Osborne No. 267

Made of light aluminum, simple toggle clamp construction. Easy to operate. Minimum length 12" for pillows, maximum length 3 feet. Rigid when in use. Can also be used as calipers for cutting large circles and blind stitching. Easy to follow instructions on each package. Points easily replaced on this high quality tool. 40" overall. Weighs 12 oz. UPC No. 64276.

## PRESSED STEEL STUFFING IRON



Detailed point →

### Osborne No. 40M-18

A utilitarian stuffing iron made of high quality steel. Creased in the center to give rigidity. Nickel plated. 18" long. Weighs 4 oz. UPC No. 64074.

## PIPING OR CHANNELING TINS



C. S. OSBORNE & CO. No. 412

C. S. OSBORNE & CO. No. 412

### Osborne No. 412

These 36" long piping tins are made of smooth aluminum. No burrs to catch on fabric while stuffing channeling, the material is soft so tins can be bent and adjusted. Sold in pairs in three different sizes for your convenience. Please specify size when ordering.

Osborne No.	Overall length (inches)	Width (inches)	Weight per pair (oz)	UPC No.
412-2	36	2	15	64362
412-3	36	3	15	64364
412-4	36	4	16	64366

## AIR FILLER TUBE



C.S. OSBORNE & CO. No. 302

Nozzle also sold separately  
**Osborne No. 302N.**



**SAVE TIME AND MONEY WITH THIS HIGH PERFORMANCE AIR STREAM.**

### Osborne No. 302

Now fill cushions, pillows, pillow backs, mattresses, mattress pads and much more the easy way. Turn tedious jobs into a simple ones by placing the back end of the Bazooka just above the loose filler container and the front end into the item to be filled. In seconds, this filler tube literally sucks the loose filler into the sleeve being filled, saving approximately 98% of the mess and waste. It's also a vacuum cleaner.

- \* Can be used with down, kapok, shredded foam, styrofoam pellets and other loose materials.
- \* Bright, lightweight aluminum - 28" length, 2" outside diameter.
- \* Operates on 60 to 90 lbs. of pressure.
- \* Completely assembled and ready for immediate use.

Weighs: 2 lbs. Overall length: 36 inches. UPC No. 10302.

## FABRIC CUTTERS FOR BUTTONS



### Osborne No. 1212

Polished, high quality and sharpened with the best technique. Cuts multiple layers of fabric at a time. Additional sizes upon request. For use in a drill press or with a hand held power drill.

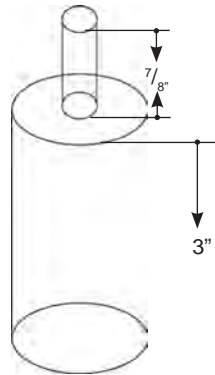

Osborne No.	Diameter of button (inches)	Diameter of cutter (inches)	Weight (oz.)	UPC No.
1212-22	1/2	1	2	64562
1212-30	3/4	1 1/4	2	64564
1212-36	7/8	1 7/16	3	64566
1212-40	1	1 1/2	4	64568
1212-45	1 1/4	1 3/4	4	64570

Fabric cutters above match button size.

## FOAM CUTTERS



### Osborne No. 1212

Extremely sharp carbonized cutting edge. For use in a drill press or with a hand held power drill. For soft materials only.

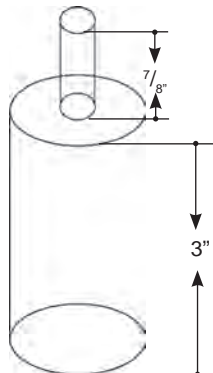

Osborne No.	Diameter of button (inches)	Weight (oz.)	UPC No.
1212 1/2	1/2	2	64534
1212 3/4	3/4	2	64536
1212 7/8	7/8	3	64538
1212 1	1	3	64540
1212 1-1/8	1 1/8	4	64542
1212 1-1/4	1 1-1/4	4	64544
1212 1-1/2	1-1/2	4	64548
1212 1-3/4	1-3/4	4	64550

Foam cutters correspond to diameter of hole.



**WEBBING, CANVAS PLIER**



**Osborne No. 250**

Made with hammer jaw, the hammer acts as a lever when a strong pull is required. Excellent tool for stretching canvas and leather as well as webbing. Vinyl handles. Fully zinc blue plating.

Length (inches)	With of jaw (inches)	Weight ea. (oz.)	UPC No.
8 1/2	3 3/8	18	54042

**WEBBING, CANVAS PLIER**



**Osborne No. 251**

Similar to our popular Osborne No. 250 Webbing, Canvas Plier but with short jaw. Fully zinc blue plating.

Length (inches)	With of jaw (inches)	Weight ea. (oz.)	UPC No.
8 1/2	1 1/2	17	54044

**CANVAS STRETCHING PLIER**



**Osborne No. 249**

Designed for today's trend to the clean line (or "hard edge") look of canvas made taut over three sides of its wooden stretcher frame. Parallel extensions permit pressure to be applied to the inner side of the wooden stretcher. Works also on heavy and primed canvas. Vinyl handles. Fully zinc blue plating.

Length (inches)	With of jaw (inches)	Weight ea. (oz.)	UPC No.
9	3 3/8	18	54046

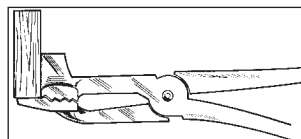



## DUCK BILL PLIERS



### Osborne No. DB1 (Serrated jaw) and Osborne No. DB1-S (Smooth jaw)

Made of malleable iron. Jaw width extra wide. Special small finger crook. Nickel plated, popular style. Also available with smooth jaw .

Length (inches)	Width of jaw (inches)	Weight ea (oz)	UPC No. (serrated)	UPC No. (smooth jaw)
7	1	6	54012	54014

## DUCK BILL PLIERS



### Osborne No. 98 and 98-S

Finest professional quality. These pliers are drop forged from high carbon steel. The jaws are hardened, tempered and carefully polished.

Ideal for stretching material in tight places where space is too limited for using ordinary stretching pliers.

**Also available with smooth jaw No. 98-S.**

Length (inches)	Width of jaw (inches)	Weight ea (oz)	UPC No. (serrated)	UPC No. (smooth jaw)
7	1	6	54016	54018

## NEEDLE NOSE STRETCHING PLIERS

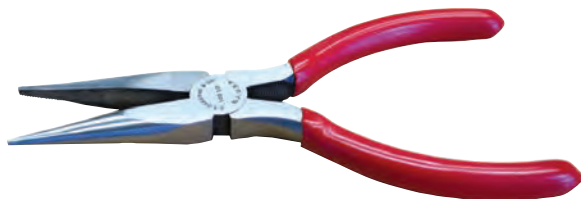

### Osborne No. 103 1/2

Forged steel. Single pivot, polished jaws, red vinyl handles. Slightly serrated jaw. Great for stretching material where space is too limited for using ordinary stretching pliers.

Overall length (inches)	Weight ea (oz)	UPC No.
5-1/2	3	54022

## GOOSENECK WEBBING STRETCHER



### Osborne No. 253

A hand stretcher to catch the webbing close to the frame with plenty of leverage. Equally efficient for right or left hand. Hickory hardwood handle with nickel plated ferrule.

Length (inches)	Width (inches)	Weight ea (oz)	UPC No.
10	4	14	64266



Gooseneck Webbing Stretcher being used with our popular Magnetic Hammer No. 33.

### Osborne No. 253-R

Rubber piece for above Webbing Stretcher. UPC No. 64267.

## WEBBING STRETCHER (Rubber End)



### Osborne No. 255

Webbing stretcher made of hardwood maple with corrugated rubber at one end, and one row of 6 sharpened steel pins at other end.

Length (inches)	Width (inches)	Weight ea (oz)	UPC No.
8	3-1/4	8	64268

## WEBBING STRETCHER (Groove End)

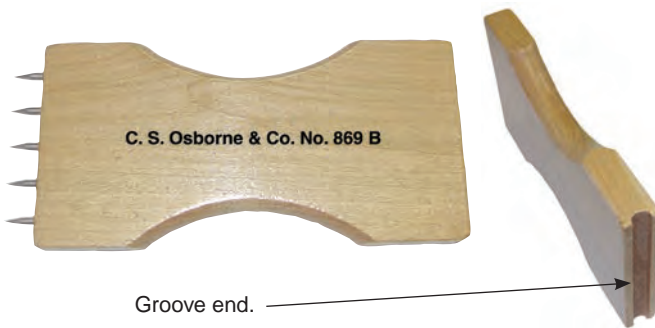

### Osborne No. 869 B

Same as above but without rubber piece on one end. It has a groove at the other end which provides secure when stretching the material.

Length (inches)	Width (inches)	Weight ea (oz)	UPC No.
6-3/4	3-1/4	6	65130

Groove end.

## PLASTIC WEBBING STRETCHER (Groove End)



### Osborne No. 869 P

Made of hard durable plastic which makes it lighter. Groove at the end to provide better security when stretching the material.

Length (inches)	Width (inches)	Weight ea (oz)	UPC No.
6-13/16	2-7/8	3	65132

Groove end.



## WEBBING STRETCHER



### Osborne No. 252

A handy tool for stretching sagless webbing and punched metal strip webbing.

Length (inches)	Width (inches)	Weight ea (oz)	UPC No.
9	3-1/2	10	64264

## LEVER SPRING STRETCHER

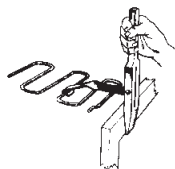

### Osborne No. 268

Used for heavy duty installations and is a safe method for installing sinuous type springs. Just set spring into rear frame clip and then pull spring into position from the front of the frame.

Length (inches)	Width of handle (inches)	Weight ea (oz)	UPC No.
4-1/4	3-1/2	2	64274

## WEBBING STRETCHER



### Osborne No. 205

Safe - No sharp teeth. English Pattern Webbing Stretcher. Made of American Hard Rock Maple. Finely finished. Toughest quality. Can be used with any webbing.

Length (inches)	Hole (inches)	Weight ea (oz)	UPC No.
11	2-3/8 x 1/2	8	64262

## RUBBER & ELASTIC WEBBING STRETCHER



### Osborne No. 263

This sturdy stretcher grips without spikes, stretches accurately and evenly. Protects edges of furniture from being marred. Designed for rubber webbing, but can be used on any webbing.

Length (inches)	Width (inches)	Weight ea (oz)	UPC No.
9-3/4	4-1/4	18	64272



## HOOK



### Osborne No. 264

Hook for pulling No. 239 clips on Elastic and Rubber Webbing.

Length (inches)	Width (inches)	Weight (oz)	UPC No.
7-1/4	2	7	58232

## SPRING PULLER HOOK



### Osborne No. 297

Can be used in conjunction with the No. 268 Lever Spring Stretcher.

Length (inches)	Width of handle (inches)	Weight ea (oz)	UPC No.
4-1/4	3-1/2	2	58242

## "T" HANDLE SPRING HOOK



### Osborne No. 269

Hardened and tempered wire secured to a white plastic handle with a screw. Used to reach deep inside seat frame and pull spring into clip.

Length (inches)	Width of handle (inches)	Weight ea (oz)	UPC No.
8	4	3	64278

## CLIP FOR RUBBER WEBBING



### Osborne No. 239

Metal clips used for rubber webbing jobs. Polished and excellent quality. Packed 250 pcs. per box or 1,250 pcs. per box. Specify preference.

Size	Width (inches)	Each per box	Weight bx(lbs)	UPC No.
S	2	250	4 1/2	14242
L	2	1250	22 1/2	14244



## CASTOR SOCKET REMOVER



### Osborne No. 87

Hardened threaded end that securely screws into socket. Slide hammer knocks it out. Work with our **T-NUTS No. 5900**. Tips only also available Osborne No. 87-TIP with UPC No. 80058

Overall length (inches)	Width (inches)	Weight (oz)	UPC No.
12-1/2	1-1/2	8	64002

## T-NUTS



### Osborne No. 5900

High quality T-Nuts clean cut thread for easy installation of legs, casters, etc. Hold fast in any type or wood. 3 sizes available.

Osborne No.	Thread	Barrel Height	# of prongs	Flange Diameter	Pcs./ box	Weight per box	UPC No.
5900-10-24	10-24	5/16"	3	23/32"	100	0.6 lbs.	78660
5900-1/4-20	1/4-20	5/16"	4	3/4"	100	0.8 lbs.	78656
5900-5/16-18	5/16-1/8	5/8"	4	7/8"	100	1.8 lbs.	78664

## SPRING BENDER

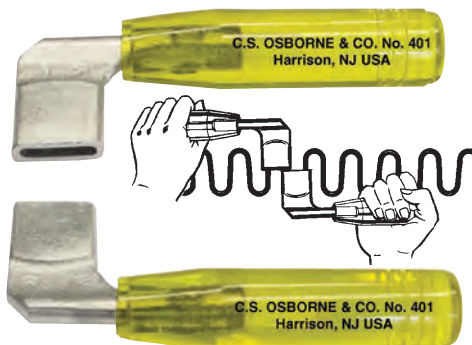

### Osborne No. 401

Spring bender, which is both simple in application and efficient in use. Nickel plated ends are slotted to fit curves which can be bent with slight pressure or can be used to unbend previously made bends. This is precisely manufactured so that arcs, angles or curves can be properly made. Available in two sizes. Sold by pairs. Specify preference.

Osborne No.	Size (inches)	Weight/pair (oz.)	UPC No.
401-1	3/8 x 1	12	14312
401-2	3/8 x 2	28	14314

Osborne No. 401-2 not only used on auto seats but also on new furniture.

## CHAIR RUBBER GLIDES



### Osborne No. 678

Fully nickel plated. Rubber cushioned for shock absorption. Packed and sold 400 pcs. per box.

Osborne No.	Head diameter (inches)	Length of tack (inches)	Weight/box (lbs)	UPC No.
678	7/8	3/4	8 lb.	35016

## CHAIR GLIDES

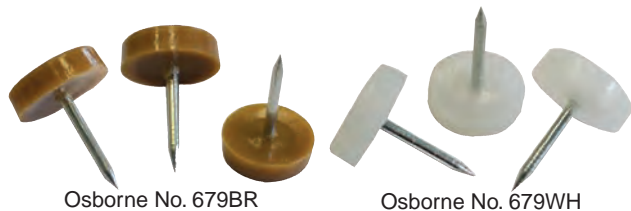

### Osborne No. 679

High quality and long lasting plastic heads with 11/16" long nickel plated tack. Sharp point. Available in **BROWN** and **WHITE**. 3/4" or 5/8" head diameter. Packed 1,000 pcs. or 5,000 pcs. per box. Please specify preference

Osborne No.	Description	Weight/ box	UPC No.
679BR-1000	3/4" diameter brown glides 1000 pcs.	4 lbs.	35000
679BR-5000	3/4" diameter brown glides 5000 pcs.	21 lbs.	35002
679BR-SM 1000	5/8" diameter brown glides 1000 pcs.	4 lbs.	35004
679BR-SM 5000	5/8" diameter brown glides 5000 pcs.	21 lbs.	35006
679WH-1000	3/4" diameter white glides 1000 pcs.	4 lbs.	35008
679WH-5000	3/4" diameter white glides 5000 pcs.	21 lbs.	35010
679WH-SM 1000	5/8" diameter white glides 1000 pcs.	4 lbs.	35012
679WH-SM 5000	5/8" diameter white glides 5000 pcs.	21 lbs.	35014

## SPRING END FORMER



### Osborne No. 404

Crimps the end of zig-zag springs and opens end coil springs.

A tough tool to make work easy. Comes with three bolts and nuts. Bolt to corner of bench or 1" block no more than 5" from edge of bench. Can be used in a vise. 5/16" holes drilled 1-3/4" apart.

Length (inches)	Width (inches)	Weight (lbs.)	UPC No.
13	1/2	1-1/4	14322

## METAL WEBBING STRETCHER (4 IN ONE TOOL)

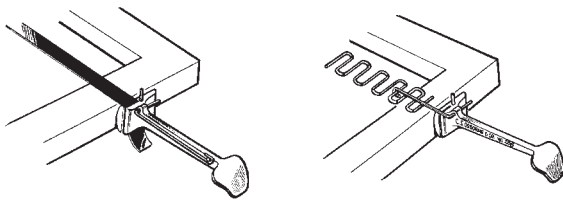

### Osborne No. 258

A versatile all metal tool for stretching various types of metal webbing, sagless springs, punched straps, etc. Flat handle gives lots of leverage.

Length (inches)	Width (inches)	Weight (lbs.)	UPC No.
9-1/2	2-1/4	1-1/4	64270



## CARBOARD TACK STRIP



### Osborne No. 4702-214

Used to attach fabric in a straight line. It gives a finished look and can be used on front boxing, outside arms, and outside backs. Sold by rolls of 214 yards.

Overall length (yards)	Width (inches)	Weight (lbs.)	UPC No.
214	1/2	3	78322

## SPRING CLIP PLIERS



NICKEL PLATED

### Osborne No. 445-3

A special plier used for applying edge wire clips to edge wire and springs. A great time saver. No. 445 regular sets Kay or Baker clips. Sets our clips Osborne No. 4450-3.

Length (inches)	Weight ea (oz)	UPC No.
7	8	54232

## BW CLIP PLIER



### Osborne No. 522

This sturdy quality tool is specially designed for rapid closing of 1/4" cushion spring (two 8 gauge wire) clips. Contoured handle with vinyl grips provide comfort and firmness.

Length (inches)	Weight ea (oz)	UPC No.
7	11	54222

## CLIPS

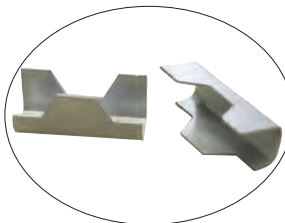

← 3 PRONG CLIP

### Osborne No. 4450-3

High quality three prong clips for use with our No. 445-3 Spring Clip Pliers. These clips are specially designed for closing with Osborne No. 445-3.

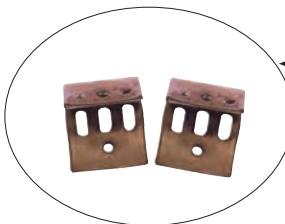

← RUBBER COATED EK CLIP

### Osborne No. 4451

High quality EK Clips. Also they are packed 250 clips to a box.



← LINED BW-CLIP

### Osborne No. 4452

Used to attach zigzag springs, edge springs and torsion springs to border and edge wires. Osborne lined BW Clips won't squeak. Solid steel construction. Osborne No. 522 BW Clip Pliers are specially designed for closing BW Clips.

Osborne No.	Length (inches)	Width (inches)	Weight per box (lbs)	Quantity per box	UPC No.
4450-3	1-1/8	1/2	3	250	14622
4450-5000	1-1/8	1/2	62	5000	14624
4451	7/8	1/2	3 1/4	250	14632
4451-5000	7/8	1/2	66	5000	14634
4452	7/8	1/2	1	100	14633
4452-5000	7/8	1/2	47	5000	14635



## KLINCH-IT TOOL

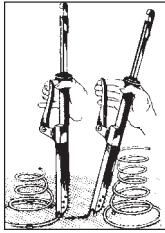

### Osborne No. 720

Quick and easy to use. Klinch-it increases your production by speeding up one of the greatest time-consuming operations. It eliminates the slow, old fashioned method of sewing springs to the web base. Instead the springs are permanently fastened with sturdy steel clips.

#### Easy to use instructions

Fill magazine with 2 strips of fasteners, hold tools upright, place nozzle over spring, press down so that prongs of the fastener pierce the webbing, then squeeze lever and fastening is finished.

Overall length (inches)	Width (inches)	Weight (lbs.)	UPC No.
27	2	3-3/4	14650

## KLINCH-IT FASTENERS

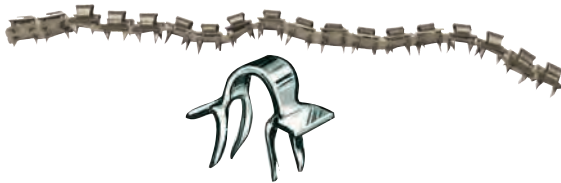

### Osborne No. 7200

Klinch-it fasteners to be used with our No. 720 Klinch-it tool. Made of high quality steel. Perfect fasteners for furniture use. Packed 5000 per box. Weight per box is of 5000 is 8 1/2 lbs. UPC No. 14652.

## WIRE FORMER

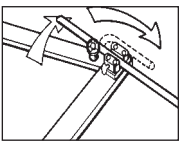

### Osborne No. 1963

A tough tool that makes difficult repairs easy. You can quickly bend the ends of no sags, edge wire and form springs right on the spot, making offsets where you need them.

Can be readily mounted in a vise for duplicating complex repetitive wire bends. Designed with heat-hardened steel to give long life.

Overall length (inches)	Width (inches)	Weight (oz)	UPC No.
21	2-3/4	12	14651

## SPRING AND WIRE CONNECTORS

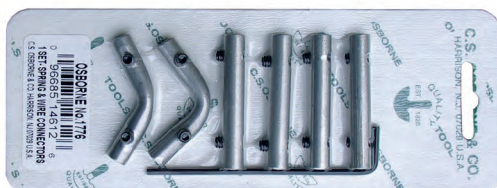

### Osborne No. 1776

For furniture and auto seat springs. Fixes broken seat springs and edge wires in minutes. Uses Allen hollow-head set screws in heavy tubing for maximum grip.

Carded for display purposes. Each set includes: 4 straight connectors, one 90 degrees connector and one 45 degrees connector plus Allen key. UPC No. 14612. Also sold separately. Please specify size or set when ordering.

Osborne No.	Length (inches)	Width (inches)	Weight (oz)	UPC No.
1776	SET	3/8	3	14612
1776-S	2	3/8	1	14617
1776-45	2	3/8	1	14613
1776-90	2	3/8	1	14615



## STARTER UPHOLSTERY KIT



### Osborne No. HB-1

A basic home upholstery kit to repair or rebuild a chair or sofa. Excellent for students and hobbyists. Professional packaging pictures all tools. Box is designed for hang up display. Weighs 1-1/2 lbs. UPC No. 14070.

EACH KIT CONTAINS			
Quantity each	Osborne No.	Description	UPC No.
1	1011	Magnetic Hammer	56014
1	255	Webbing Stretcher	64268
1	201	Tack Claw	64224
1	501-1/2 3	Curved Needle	15136
1	501-1/2 6	Curved Needle	15144
1	504-10	Straight Needle	15370
36	190 3	Upholstery Pins	15932
1	B-1 Book	Instruction Booklet	14044

## DO IT YOURSELF KIT



### Osborne No. B-4

The perfect kit for upholstery work. Includes easy to follow instruction booklet. Professionally packaged for hang up display and pictures all tools in kit. Weighs 1-1/2 lbs. UPC No. 14050.

EACH KIT CONTAINS			
Quantity each	Osborne No.	Description	UPC No.
1	1011	Tack Hammer	56014
1	255	Webbing Stretcher	64268
1	146	Claw Tool	64216
1	504-6	Straight Needle 6"	15366
1	501-1/2 3	Curved Uph. Needle 3"	15136
1	501-1/2 4	Curved. Uph. Needle 4"	15140
1	B-1 Book	Instruction Booklet	14044

## INSTRUCTION BOOKLET & YARDAGE CHART

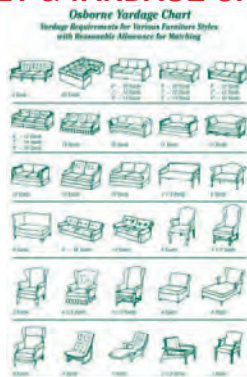

### Osborne No. B-1 BOOK

Our 16 page Upholstery Kit Instruction booklet for reinforcing & rebuilding furniture in your home. Inside cover pages depict yardage chart. UPC No. 14044.

### Yardage Chart Poster

A FREE 32" x 27" Yardage Chart Poster is also available.

## INTERMEDIATE UPHOLSTERY KIT



### Osborne No. B-11

This kit contains the basic tools and needles required for reupholstery work, but in it, we have eliminated a few of the more expensive professional items in order to bring the cost down to a more popular level for use by schools or other institutions. It serves as an intermediate kit between our popular B-1 Upholstery Kit and the B-7 Pro Upholstery Kit. Professional box cover pictures all tools in kit. Weighs 2-1/2 lbs. UPC No. 14062.

EACH KIT CONTAINS			
Quantity each	Osborne No.	Description	UPC No.
1	1011	Tack Hammer	56014
1	253	Gooseneck Webbing Stretcher	64266
1	120 1/2	Staple Lifter	64006
1	402	Ripping Chisel	53212
1	76 1/2	Square Point Knife	60046
1	520-8	Regulator	66064
1	501-1/2 3	Curved Needle	15136
1	501-1/2 4	Curved Needle	15140
1	501-1/2 6	Curved Needle	15144
1	502-1/2 4	Curved Needle	15270
1	504-8	Straight Needle	15368
1	684 10	10" Shears	14430
36	190 3	3" Upholstery Pins	15932
1	88-WH	Taylor Chalk - White	65134
1	B-1	Instruction Booklet	14044

## PRO UPHOLSTERY KIT



### Osborne No. B-7

This all-inclusive kit fills the needs of the journey man upholsterer, the trainee and the ambitious amateur. Contains twelve items of top quality C.S. Osborne tools, needles and our instruction booklet. Professionally boxed. Box cover pictures all tools. Weighs 5 lbs. UPC No. 14056.

EACH KIT CONTAINS			
Quantity each	Osborne No.	Description	UPC No.
1	33	Bronze Magnetic Hammer	56042
1	253	Gooseneck Webbing Stretcher	64266
1	120 1/2	Staple Lifter	64006
1	402	Ripping Chisel	53212
1	76 1/2	Square Point Knife	60046
1	396-2	White Rubber Mallet	61018
1	306-1/2 8	Light Regulator 8" 9 Gauge	16034
1	K-3	Needle Card	15014
1	K-5	Needle Card	15018
1	684 10	10" Shears	14430
36	190 3	3" Upholstery Pins	15932
1	88-WH	Taylor Chalk - White	65134
1	B-1	Instruction Booklet	14044

## RIPPING CHISEL



### Osborne No. 402

A translucent amber handle for quick identification. Perfect balance. Forged steel blade with correct angle on chisel edge. Shouldered tang, tough construction.

Overall length (inches)	Blade length (inch)	Width of edge (inches)	Weight ea (oz)	UPC No.
8	3-5/8	1/2	5	53212

## BENT RIPPING CHISEL



### Osborne No. 761W 1/2

Forged steel blade. Hardwood handle with reinforced striking end bent at the correct angle. Nickel plated.

Blade length (inch)	Overall length (inches)	Weight ea (oz)	UPC No.
5	9-3/4	6	64767

## BENT RIPPING CHISEL



### Osborne No. 761PH 1/2

Similar to 761W 1/2 with durable cellulose acetate handle ideal for stronger work. Nickel plated.

Blade length (inch)	Overall length (inches)	Weight ea (oz)	UPC No.
4-3/4	9-1/4	6	64776

## BENT RIPPING CHISEL - with Claw



### Osborne No. 761W 3/4

Similar to our 761W 1/2 but with claw in blade. Nickel plated.

Blade length (inch)	Overall length (inches)	Weight ea (oz)	UPC No.
5	9-3/4	6	64768



## STRAIGHT RIPPING CHISEL

### Osborne No. 762 P

Straight ripping chisel. Forged steel blade. Nickel plated with strong cellulose acetate handle for long lasting.



Blade length (inch)	Overall length (inches)	Weight ea. (oz)	UPC No.
5	9-1/8	5	64782

## COMBINATION TOOL

### Osborne No. 402 1/2

A beautifully finished tool with a translucent amber handle designed to fit the hand with perfect balance. Forged highly polished steel blade. Shouldered tang to prevent driving into handle. Combined ripping tool and tack puller.



Blade length (inches)	Overall length (inches)	Weight ea (oz)	UPC No.
3-3/4	8-1/4	6	53216

## BENT RIPPING CHISEL

### Osborne No. 339

Rugged tool. Carefully hardened.



Cutting edge (inches)	Stock (inches)	Length (inches)	Weight each (lbs) (oz)	UPC No.
1 5/8	7/8	18	2 6	53182

## MOULDING LIFTER

### Osborne No. 262

Forged from high quality hexagon tool steel. Hardened and tempered. Individually boxed.



Length (inches)	Stock (inches)	Weight ea (oz)	UPC No.
10 1/2	1/2	14	14292

## ZIPPER STOPS PLIER

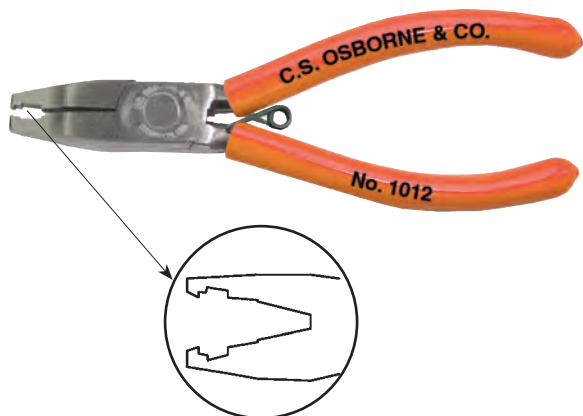

### Osborne No. 1012

Made of high quality forged steel. Vinyl handles for easy gripping. Spring loaded. Designed to install any kind of top stops on zipper chain. Unique jaw design.

Overall length (inches)	Weight each (oz.)	UPC No.
7 1/4	9	64508

## STAINLESS STEEL ZIPPER STOPS



### Osborne No. 1013

Made of stainless steel. Size number 10. Packed and sold in bags of 100 pcs. These are the top stops for the zipper chain and can be set using our zipper stop plier Osborne No. 1012.

Quantity / bag (pcs.)	Weight / bag (oz.)	UPC No.
100	1	64500

## ZIPPER JIG



### Osborne No. 1014

- \* Holds YKK<sup>®</sup> zippers sliders from sizes # 2.5 to 10.
- \* Lower clamp securely holds zipper jig to your counter.
- \* Upper clamp is used for locking jig rod in any direction.
- \* Also allows you to put zipper on backwards.
- \* Fully nickel plated.
- \* Instructions are included.



Height (inches)	Weight each (oz.)	UPC No.
7	10	64506



## PATTERN AND CABINET MAKERS STEEL PINCH DOGS

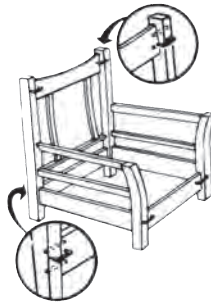

### Osborne No. 89

Made from the finest quality high carbon steel. Hardened and tempered for the long duration. Square corners over edges make easy driving. Different sizes available.

Size No.	Length (inches)	Weight ea. (oz.)	UPC No.
3/4	3/4	1	64132
1	1	1	64134
1 1/4	1 1/4	1	64136
1 1/2	1 1/2	1	64138
2	2	1	64140

Size No.	Length (inches)	Weight ea. (oz.)	UPC No.
2 1/2	2 1/2	2	64142
2 3/4	2 3/4	2	64144
3	3	2	64146
3 1/2	3 1/2	2	64148

## PINCH DOG KIT



### Osborne No. K-89

A hang up display card composed of the most popular sizes.

Sizes in the card			Weight / card (oz.)	UPC No.
1 1/2	2	3	4	64150

## STAINLESS STEEL PINCH DOG



Hammer head

Pattern #  
Des. 247,896

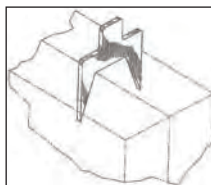

### Osborne No. 89SS 1-3/4

Designed with HAMMER HEAD. It is **reusable** by upholsterers, cabinet makers and pattern makers as an all-purpose fastener for gluing clamps, column assembly, clamping and jiggling.

Overall length (inches)	Thickness (inches)	Weight each (oz.)	UPC No.
1 3/4	1/8	3	64852

## GLUE STICKS



### Osborne No. 2000

Hot melt adhesive for use with glue gun. 12 sticks per bag.

Overall length (inches)	Diameter (inches)	Weight each (oz.)	UPC No.
10	7/16	4	64636

## GLUE STICKS - BULK PACK



### Osborne No. 2003

Packed 22 lbs. per box. Approximate 375 glue sticks.

Box dimensions (inches)	Weight / box (lbs.)	UPC No.
22 x 11 x 4	22	64638

## CLAY BASED MARKING CHALKS



Box contains:

- \* 8 White chalks.
- \* 2 Yellow chalks.
- \* 1 Red chalk.
- \* 1 Blue chalk.

### Osborne No. 88

Clay based and much easier to erase. Other chalks that are not clay based will leave a grease on cottons and other fabrics. Also works on glass and vinyl that where chalks don't work. Due to the shape of this chalk a sharp marking edge is maintained. UPC No. 64336.

### Osborne No. 85

Same as above but contains 12 WHITE chalks. UPC No. 14006.



## WOOD RULER

### Osborne No. 160

Made from properly dried northern hard maple with brass ends to meet all state measuring standards codes. Smooth finish in clear lacquer. Has 1/8" calibrations. Hole punched on one end for hanging display. 3 lengths available.



Osborne No.	Length (inches)	Width (inches)	Thickness (inches)	Weight ea. (oz.)	UPC No.
<b>160-3C</b>	36	1 1/2	1/4	8	64084
<b>160-5C</b>	60	1 1/2	1/4	12	64086
<b>160-6C</b>	72	1 1/2	1/4	18	64088

## ALUMINUM STRAIGHT EDGE RULER

### Osborne No. 802

One edge for standard measurements, one edge for metric. Sturdy and wide. Scales etched in black on silver background, one side only. Finish anodized for performance. Three lengths available. Hole punched on one end for hanging.

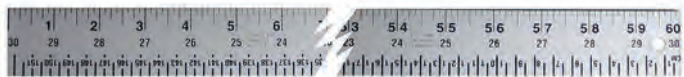

Osborne No.	Length (inches)	Width (inches)	Thickness (inches)	Weight ea. (oz.)	UPC No.
<b>802-36</b>	36	1 1/2	1/8	9	64094
<b>802-54</b>	54	1 1/2	1/8	13	64096
<b>802-60</b>	60	1 1/2	1/8	15	64098

## ALUMINUM RULER (inches & metric)

### Osborne No. 161

Made of anodized aluminum. One side shows graduation in inches along both edges with measurements also from center of rule. When turned over, the opposite side of the rule has graduations in metric along one side. Hole on one end for hanging.



Length (inches)	Width (inches)	Thickness (inches)	Weight ea. (oz.)	UPC No.
60	1 1/2	1/8	8	64092

## ALUMINUM STRAIGHT EDGE RULER

### Osborne No. 60SE

Markings on one side only. Heavy wide aluminum. Hole punched on one end for hanging.

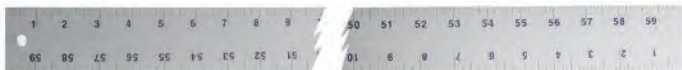

Length (inches)	Width (inches)	Thickness (inches)	Weight ea. (oz.)	UPC No.
60	2	1/8	26	64082



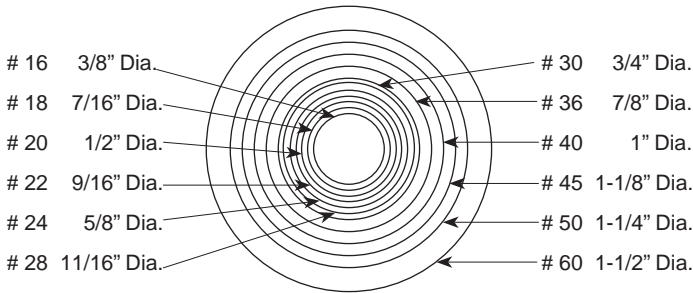

Button Chart - Actual sizes.

### What is Required to Cover Buttons?

- 1.- A Button Covering Hand Press Machine.
- 2.- Steel Cutters and Covering Dies. A separate set of dies is required to make each size of button for each type of material. Always use the correct die for your material.
- 3.- Buttons Molds . Consists of a shell and a back. The shell is covered and crimped around the back by the die.

### CHART OF BUTTON SIZES

The standard measurement for buttons is 40 lignes per inch. Therefore size 30 is 3/4", size 60 is 1-1/2", etc. Dimensions shown are for buttons before covering.

## No. 1 HAND BUTTON COVERING MACHINE

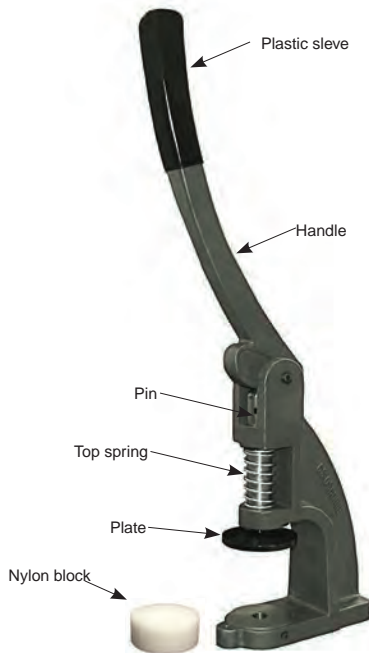

### Osborne No. W-1

High quality hand machine. Cuts fabric and covers buttons. Works with 2 piece die and short cutters. The W-1 Button machine has a reinforced frame and handle. Bolts to a table for added stability. Comes complete with a nylon block for cutting covers. It produces 80 to 120 buttons per hour.

This machine also sets GROMMETS (plain and spurs), SNAPS & VENTILATORS with appropriate dies. Nylon block can be also be purchased separately. Minimum throat 1" and maximum 2". Spare parts are also sold separately.

Osborne No.	Height (inches)	Weight each (lbs)	UPC No.
W-1	25	19	75000

#### REPLACEMENT PARTS

Osborne No.	Description	UPC No.
W-1H	Handle	75008
W-1P	Pin	75012
W-1PL	Plate	75014
W-1 SPRING	Top spring	75002
W-1W	Nylon block	75004

## No. 2 HAND BUTTON COVERING MACHINE

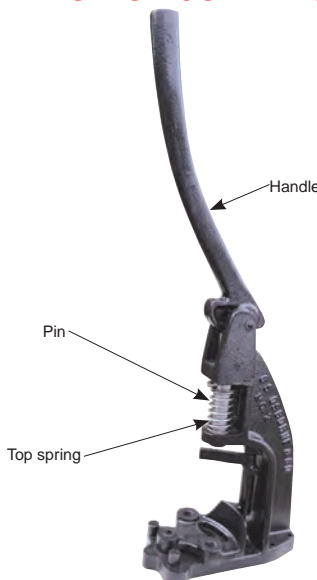

### Osborne No. W-2

Works with 3 piece Swivel Die and long cutters for fast production. Heavy ribbed construction. Long handle provides leverage and allows operator to work at higher speed. This machine can produce 180-250 buttons per hour. Replacement parts are also available.

Osborne No.	Height (inches)	Weight ea (lbs)	UPC No.
W-2	23	22	75016

#### EXTRA PARTS

Osborne No.	Description	UPC No.
W-2 Spring	Top spring for Machine	75020
W-2H	Handle for Machine	75018

## No. 3 PNEUMATIC BUTTON MACHINE

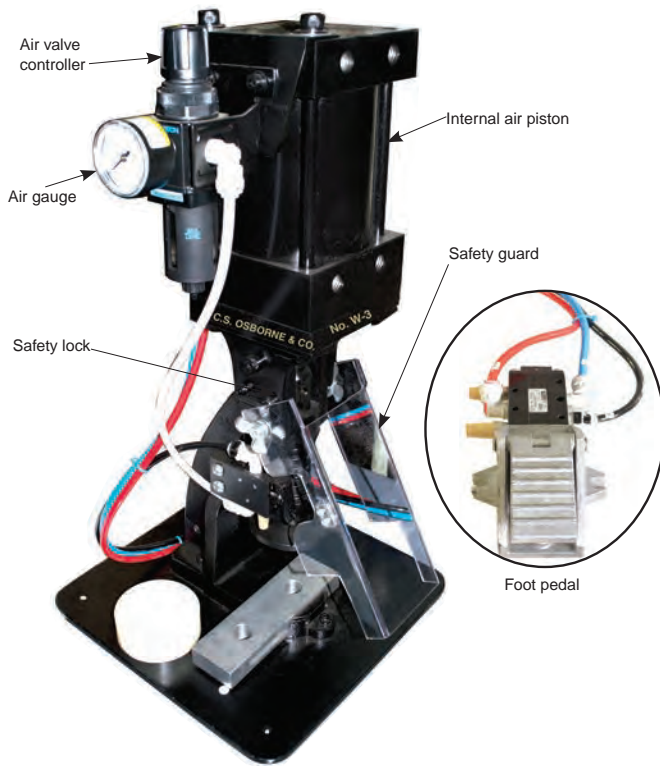

### Osborne No. W-3

Works with 2 piece button die and also cuts the material with a short cutter. Operates with 60 to 120 lbs. of compressed air. Foot pedal included. Clear plastic safety guard locks the machine. Easy to assemble and mount to bench or work station. **This machine also sets plain or spur grommets, ventilators, rapid rivets and snaps with appropriate dies.** Full instructions provided.

Osborne No.	Height (inches)	Weight each (lbs)	UPC No.
W-3	23	47	75010

## No. 4 PNEUMATIC BUTTON MACHINE

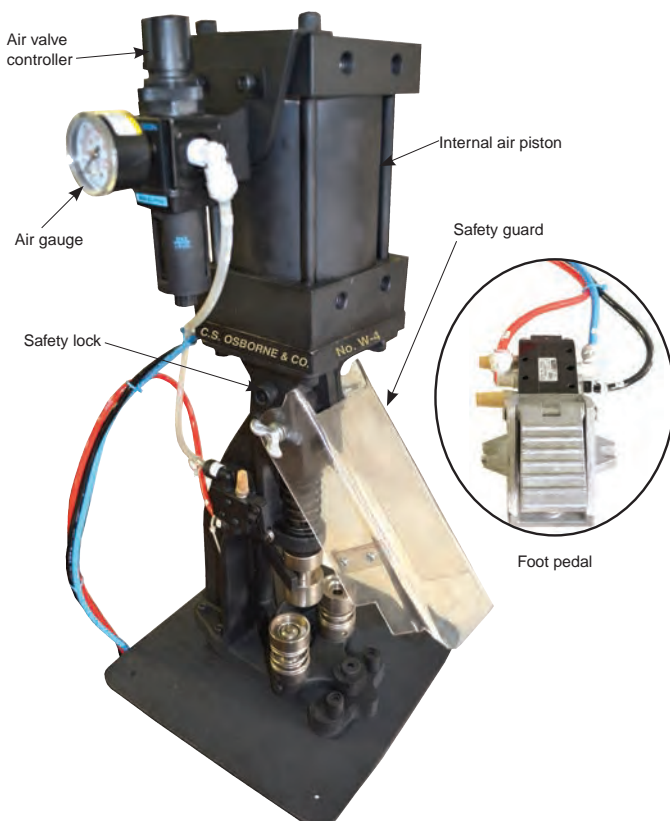

### Osborne No. W-4

Works with 3 piece Swivel die to increase your production. Operates with 60 to 120 lbs. of compressed air. Foot pedal included. Clear plastic safety guard locks the machine. Easy to assemble and mount to bench or work station. Full instructions provided.

Osborne No.	Height (inches)	Weight each (lbs)	UPC No.
W-4	23	47	75006

## BUTTON COVERING (INSTRUCTIONS)



1.- Place material on the nylon block. Lay cutter on material. Pull on handle to cut button covers. Fold or stack material to cut more pieces at one time.

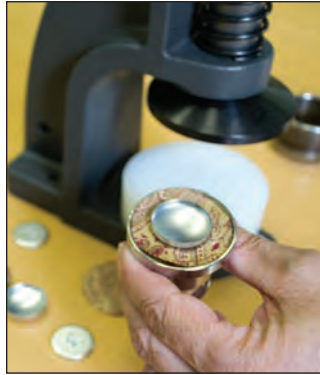

2.- Turn top of the two piece die. Place the cut material on the die, then center the shell on top of the material as shown.



3.- Holding the die use the wood dowel to push in the shell.



4.- Lay wire eye on the bottom die with the loop facing down.



5.- Place the two piece die together on the machine. Lock in the bottom piece die with the Allen wrench provided.



6.- Firmly pull on handle to cover the button.



7.- A secure covered button.



### BUTTON DIES TYPES

All dies are CNC precision machined, nickel plated and made of high quality steel. Cutters are heat treated and have sharp edges engineered for accurate cutting and long life.

**MATERIAL THICKNESS.** Always buy a set of dies made exactly for your material thickness. If you have a variety of material thickness, you will need more than one set of dies.

TO SELECT THE PROPER DIE USE THIS TABLE

Description	Designation
Light material	LU
Regular material	HU
Heavy material	HUX

### BUTTON DIES & SHORT CUTTER FOR W-1 & W-3

Consists of 2 pieces dies & one Short cutter. Set also includes a wooden dowel used to push the material into the die. Please specify the type of material that you are working with: HU, HUX or LU.

Following are the part numbers for "HU" material.



2 PCS. DIE " HU " AND SHORT CUTTER FOR W-1 AND W-3						
Osborne No.	WDIHUC162	WDIHUC182	WDIHUC202	WDIHUC222	WDIHUC242	WDIHUC282
Size	16	18	20	22	24	28
Button diameter (inches)	3/8	7/16	1/2	9/16	5/8	11/16
UPC No.	75808	75810	75812	75948	75956	75958
2 PCS. DIE " HU " AND LONG CUTTER FOR W-2 AND W-4						
Osborne No.	WDIHUC302	WDIHUC362	WDIHUC402	WDIHUC452	WDIHUC502	WDIHUC602
Size	30	36	40	45	50	60
Button diameter (inches)	3/4	7/8	1	1-1/8	1-1/4	1-1/2
UPC No.	75964	75972	75980	75988	75996	76004

DIES & CUTTERS ARE ALSO SOLD SEPARATELY

### BUTTON DIES & LONG CUTTER FOR W-2 & W-4

Consists of 3 piece Swivel dies & one Long cutter. Please specify the type of material that you are working with: HU, HUX or LU. Following are the part numbers for "HU" material.



3 PCS. DIES " HU " AND LONG CUTTER FOR W-2 AND W-4				
Osborne No.	WDIHUC223	WDIHUC243	WDIHUC303	WDIHUC363
Size	22	24	30	36
Button diameter (inches)	9/16	5/8	3/4	7/8
UPC No.	75952	75960	75968	75976
3 PCS. DIES " HU " AND LONG CUTTER FOR W-2 AND W-4				
Osborne No.	WDIHUC403	WDIHUC453	WDIHUC503	WDIHUC603
Size	40	45	50	60
Button diameter (inches)	1	1-1/8	1-1/4	1-1/2
UPC No.	75984	75992	76000	76008

DIES & CUTTERS ARE ALSO SOLD SEPARATELY



### COMBINATIONS or COMBOS

The COMPLETE BUTTON consists of one SHELL and any kind and type of back like WIRE EYE, etc. When you are ordering make sure you state whether you want the complete button or just one part of it. The complete button number starts with WCM then the size of the button, then the letter of the backs (like WE for wire eye or ND for no dent nail, etc.), then the type of shell (like SS for soft shell, RR for Rust Resistant, etc.) and finally the quantity pack (1GR for one gross box or 5GR for 5 gross box).

- WCM= COMBO
- WE= WIRE EYE
- PR=PRONG
- TN=THREADED NAIL
- ND=NO DENT NAIL
- PSR=PLASTIC SNAP RING
- AS=ALUMINUM SHELL
- SS=SOFT SHELL
- RR=RUST RESISTENT
- SH=SUPER HOOK
- CW=CARBOARD WAD
- CO=COLLET
- PB=PIVOT BACK
- PT=PIVOT TACK
- 1GR=ONE GROSS BOX
- 5GR=FIVE GROSS BOX
- 25GR=TWENTY FIVE GROSSBOX
- 50GR=FIFTY GROSS BOX

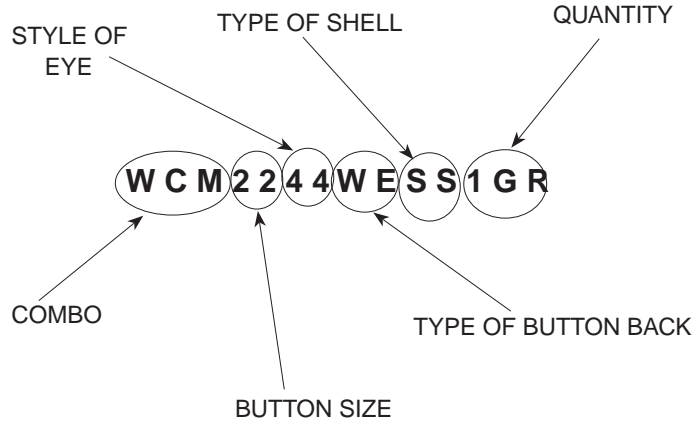

STYLE 44 WIRE EYE WITH SOFT SHELL 5 GROSS BOX (ALSO AVAILABLE IN 1 GROSS BOX)						
Osborne No.	WCM1644WESS5GR	WCM1844WESS5GR	WCM2044WESS5GR	WCM2244WESS5GR	WCM2444WESS5GR	WCM2844WESS5GR
Size	16	18	20	22	24	28
UPC No.	73196	73204	73212	75120	75200	74218
Osborne No.	WCM3044WESS5GR	WCM3644WESS5GR	WCM4044WESS5GR	WCM4544WESS5GR	WCM5044WESS5GR	WCM6044WESS5GR
Size	30	36	40	45	50	60
UPC No.	75344	75464	75540	75592	75636	75672

WIRE EYE STYLE # 44 WITH SOFT SHELLS



WIRE EYE STYLE # 9 WITH SOFT SHELLS

STYLE 9 WIRE EYE WITH SOFT SHELL 5 GROSS BOX (ALSO AVAILABLE IN 1 GROSS BOX)				
Osborne No.	WCM229WESS5GR	WCM249WESS5GR	WCM309WESS5GR	WCM369WESS5GR
Size	22	24	30	36
UPC No.	75156	75216	75368	75488
Osborne No.	WCM409WESS5GR	WCM459WESS5GR	WCM509WESS5GR	WCM609WESS5GR
Size	40	45	50	60
UPC No.	75560	75612	75652	75688



## WIRE EYES

Also known as BUTTON BACKS. There are 2 styles available: No. 9 and No. 44. **Wire Eye No. 9** Standard has a larger eye. **Wire Eye No. 44** has a smaller eye and is intended to be used against delicate material to minimize piercing and runs.

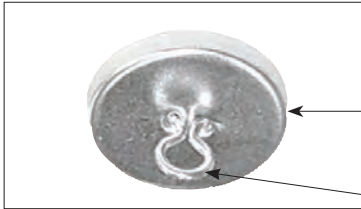

**STYLE # 9**

Strong wire eye. LARGE LOOP.  
Large opening for ease of threading  
tufting twine.

Uniform Dimensions.  
Smooth edges help avoid cutting even  
the most difficult materials.

Perfectly rounded loop won't fray twine.

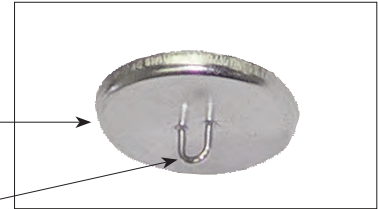

**STYLE # 44**

"U" shape SMALLER loop.  
Specially designed to prevent fabric  
damage and pull through in delicate  
materials.

STYLE No. 9 WIRE EYE BUTTON BACK ONLY 5 GROSS BOX (ALSO AVAILABLE IN 1, 25 & 50 GROSS)								
Osborne No.	WWE229-5	WWE249-5	WWE309-5	WWE369-5	WWE409-5	WWE459-5	WWE509-5	WWE609-5
Button Size	22	24	30	36	40	45	50	60
UPC No.	77033	78064	78096	78124	78156	78188	78220	78254

STYLE No. 44 WIRE EYE BACK ONLY 5 GROSS BOX (ALSO AVAILABLE IN 1, 25 & 50 GROSS)						
Osborne No.	WWE1644-5	WWE1844-5	WWE2044-5	WWE2244-5	WWE2444-5	WWE2844-5
Button Size	16	18	20	22	24	28
UPC No.	76524	76534	76544	78016	78048	78054
Osborne No.	WWE3044-5	WWE3644-5	WWE4044-5	WWE4544-5	WWE5044-5	WWE6044-5
Button Size	30	36	40	45	50	60
UPC No.	78080	78108	78140	78172	78204	78236

## SHELLS

High quality Shells which are the top part of button. We offer 3 kinds of shells: SOFT Shells, ALUMINUM Shells and RUST RESISTANT shells. Soft Shells are the most popular since they prevent tearing of the materials. Rust Resistant Shells minimize rusting problems and the resultant damage to the upholstery. Shells are sold in: 1, 5, 25 and 50 gross boxes. The most popular quantity is 5 gross box. Please specify when ordering; if not we will ship boxes of 5 gross.



Soft shell



Aluminum shell



Rust resistant shell

SOFT SHELL. 5 GROSS BOX (ALSO AVAILABLE IN 1, 25 OR 50 GROSS BOX)												
Osborne No.	WSHS16-5	WSHS18-5	WSHS20-5	WSHS22-5	WSHS24-5	WSHS28-5	WSHS30-5	WSHS36-5	WSHS40-5	WSHS45-5	WSHS50-5	WSHS60-5
Size	16	18	20	22	24	28	30	36	40	45	50	60
UPC No.	76462	76472	76482	77620	77636	77642	77652	77668	77684	77700	77716	77732

ALUMINUM SHELL. 5 GROSS BOX (ALSO AVAILABLE IN 1, 25 OR 50 GROSS BOX)						
Osborne No.	WSHA22-5	WSHA24-5	WSHA30-5	WSHA36-5	WSHA40-5	WSHA45-5
Size	22	24	30	36	40	45
UPC No.	77284	74724	77300	77316	77332	77348

RUST RESISTANT SHELL. 5 GROSS BOX (ALSO AVAILABLE IN 1, 25 OR 50 GROSS BOX)											
Osborne No.	WSHRR16-5	WSHRR18-5	WSHRR20-5	WSHRR22-5	WSHRR24-5	WSHRR30-5	WSHRR36-5	WSHRR40-5	WSHRR45-5	WSHRR50-5	WSHRR60-5
Size	16	18	20	22	24	30	36	40	45	50	60
UPC No.	76414	76426	76438	77492	77508	77524	77540	77556	77572	77588	77604



## PRONGS (Clinch Buttons)

Great for high speed production. Used on headboards, bars, restaurant booths and wide range of furniture styles. Very effective for pre-tufting of covers before attachment to the furniture frame.

Round edge helps prevent holes from enlarging after application.

Wire is precision tempered. Just the right hardness to keep prongs from pulling out, yet easy for your installer to bend.

Leg is longer for ease of bending.

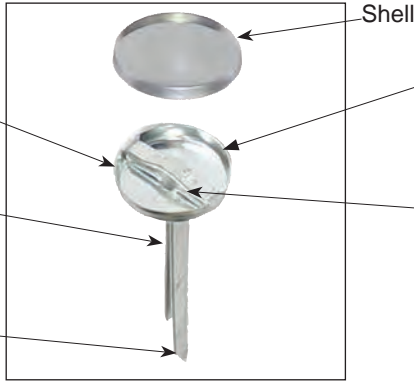

Staked edges are rounded to prevent material from tearing.

Prong wire is solidly staked to collet for safety and ease of installation.

PRONGS FIVE GROSS BOX (ALSO AVAILABLE IN 1, 25 AND 50 GROSS BOX).									
Osborne No.	WPR22112-5	WPR222-5	WPR22212-5	WPR242-5	WPR24212-5	WPR30112-5	WPR302-5	WPR30212-5	WPR303-5
Size	22			24		30			
Length (inches)	1 1/2	2	2 1/2	2	2 1/2	1 1/2	2	2 1/2	3
UPC No.	76888	76904	76920	76936	76952	76968	76984	77000	77016
Osborne No.	WPR36112-5	WPR362-5	WPR36212-5	WPR40112-5	WPR402-5	WPR452-5			
Size	36			40		45			
Length (inches)	1 1/2	2	2 1/2	1 1/2	2	2			
UPC No.	77032	77048	77064	77080	77092	77104			

## PRONG WASHERS

Use for extra safety in preventing prongs from pulling out. Available in metal and fibre material. 3 sizes.



**Metal 1"**  
**No. 1 Washer**  
Low cost. Beveled for additional strength.



**Metal 1 3/8"**  
**No. 3 Washer**  
Extra wide, more holding area.

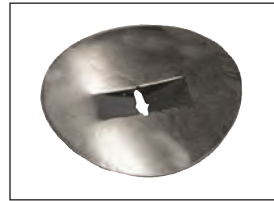

**Metal 15/16"**  
**No. 15 Spring Washer.**  
Made of precision tempered spring steel. Prong is forced through opening and locked by spring action.

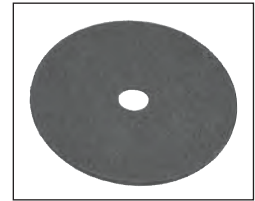

**Fibre 1 3/8"**  
**No. 5 Washer**  
Fibre Washer is strong and completely squeak proof.



Prong with metal washer

PRONG WASHERS 5 GROSS BOX (Also available in 1, 25 & 50 gross box)				
Osborne No.	WWAM1-5	WWAM138-5	WWAF138-5	WWASP15-5
Description	Metal Washer # 1	Metal Washer # 3	Fibre Washer # 5	Spring Washer # 15
Diameter	1"	1-3/8"	1-3/8	15/16"
UPC No.	77948	77964	77932	78002

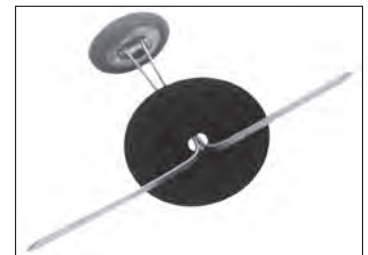

Prong with fibre washer

## SPRING METAL WASHER



### Osborne No. WWAS10

Also know as Spring Lock Washer. Locks and secures the threaded nails when these are inserted into the upholstered construction. Perfect for working near edges or corners. Packed and sold in 1, 5, 25 or 50 gross boxes.

Osborne No.	Length (inches)	Width (inches)	UPC No.
WWAS10-5	5/16	7/8	77988

## THREADED NAILS (For use with Spring Washer)

Nail is rigidly welded to collet.

Deep threads are designed so spring washer slides on easy, yet can't pull off.

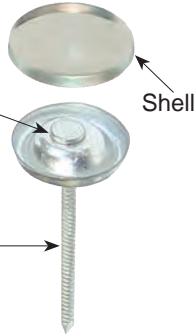

When anchored with a spring lock washer, the Threaded Nail is a fast, positive, alternative to prong tufting. Just insert the nail through the upholstered construction and fasten in on the back with a spring washer.



THREADED NAILS 5 GROSS BOX (ALSO AVAILABLE IN 1, 25 & 50 GROSS BOX).											
Osborne No.	WTN2278-5	WTN22112-5	WTN222-5	WTN2478-5	WTN3078-5	WTN30112-5	WTN302-5	WTN3634-5	WTN3678-5	WTN36112-5	WTN362-5
Size	22			24	30			36			
Length (inches)	7/8	1-1/2	2	7/8	7/8	1-1/2	2	3/4	7/8	1-1/2	2
UPC No.	77788	77756	77772	74730	77844	77812	77828	77892	77908	77860	77876

## NO DENT ASSEMBLED NAIL (For driving into wood)

Corrugations on nail grip wood.

Hardened steel

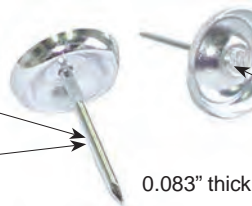

No dent collect. Nail is securely welded to collet.

Hardened and tempered steel nail. For driving into wood. Buttons are driven through fabric and foam directly into frame. Small corrugations allow for easy driving, help prevent buttons from pulling out.

NO DENT NAILS 5 GROSS BOX (ALSO AVAILABLE IN 1, 25 AND 50 GROSS BOX)														
Osborne No.	WND2234-5	WND2278-5	WND221-5	WND281-1	WND281-5	WND3034-5	WND301-5	WND30114-5	WND30112-5	WND3634-5	WND361-5	WND36114-5	WND451-5	WND6034-5
Size	22			28		30				36		45	60	
Length (inches)	3/4	7/8	1	1	1	3/4	1	1-1/4	1-1/2	3/4	1	1-1/4	1	3/4
UPC No.	76672	76688	74677	74679	74681	76752	76704	76736	76720	76792	74682	74688	76808	76378

## CONCAVE NAIL BUTTON DRIVING TOOL



### Osborne No. 915

Used to hammer the nail button into the upholstered construction. Concave head to prevent the nail button from being damaged when hammered.

Length (inches)	Head diameter (inches)	Weight (oz)	UPC No.
4 1/4	1	77988	76350





## UNASSEMBLED NYLON SNAPS (Nylon Snap Rings)

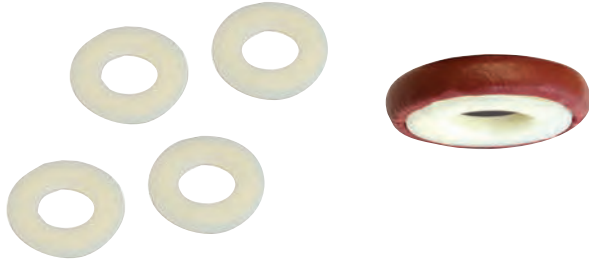

Also called Plastic Snaps Rings. Ideal for use on furniture, recreational vehicles, manufactured housing, etc. This nylon back is specially designed to snap onto a Durable Wood Screw or Durable Snap when covered. This provides a secured hold with little chance of rust or discoloration. 2 sizes available. **Sold with and without shells.**

UNASSEMBLED SNAPS - 5 GROSS BOX		
Osborne No.	WPSR30-5	WPSR30-5
Size	30	36
UPC No.	76868	74712

Also available in 1, 25 or 50 gr. boxes.

## PLASTIC DOMED BUTTONS



Ready to use button. Available only in button size No. 40. Made of Nylon, one piece construction. Available in: dark brown, beige and white. Super hook designed.

PLASTIC DOMED BUTTONS 5 GR. BOX			
Osborne No.	WPLDBB-5	WPLDB-5	WPLDBW-5
Color	Beige	Dark brown	White
UPC No.	76836	76848	76860

Also available in 1, 25 or 50 gr. boxes.

## DOUBLE BUTTONS OR JOINED PIVOTS

When a design calls for buttons on both sides of a pillow or cushion, chair backs, etc. use our Joined Pivots. It is composed of two parts: the female part which is the Single Pivot back and the male part which is the Pivot tack back.

Available in the following sizes: 22, 24, 30, 36, 40, 45, and 60. The female half is assembled with a retaining pivot spring steel lock washer which mates with the serrated pivot tack of the male half. Although easily snapped together by hand pressure, the buttons hold tight. It won't come apart.

### Set consist of:

- 1 Gross of Pivot Back
- 1 Gross of Pivot Tack
- 2 Gross of Shells

Tack lengths available:  
3/8", 1/2", 3/4" and 1.

Specify your preference  
when ordering.

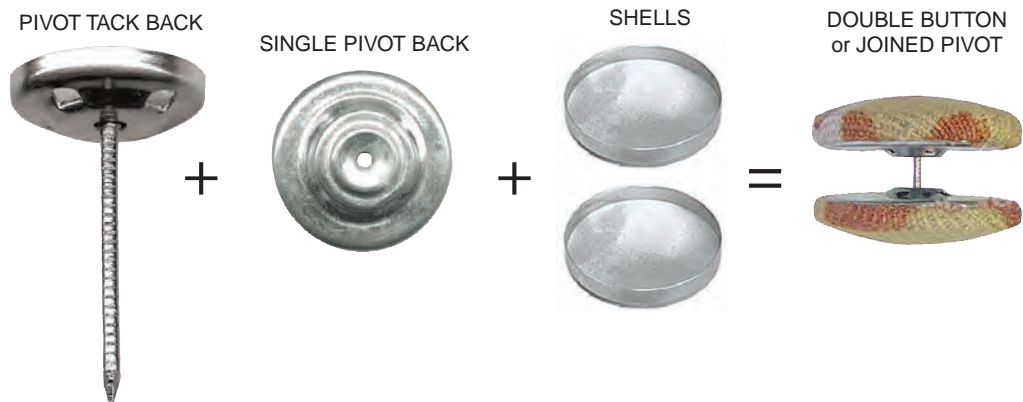

Osborne No.	WCM2212PBPTSSSET						
Button size	22	24	30	36	40	45	60
Length	1/2	1/2	1/2	1/2	1/2	1/2	1/2
UPC No.	73214	74161	73234	73246	73256	73264	73276

Individual components are also sold separately



## NYLON SUPER HOOK

Applicable on : reversible cushions, nonreversible cushions, tight seats, chair backs, bolsters, hassocks, etc. Fast installation, low cost, perfect tufting depth every time. Knots won't come untied due to operator fatigue.

### 1. BUTTON SITS FLAT

Tapered shank allows button to sit flat.

### 2. INSTALLS FASTER

Exclusive slope design guides loop into hook with one pass. Cuts production time, cuts costs.

### 3. WON'T RIDE UP

Curved double snubbers keep loop from riding up into lock channels.

### 4. NO FRAYING

Smooth edges will not fray twine.

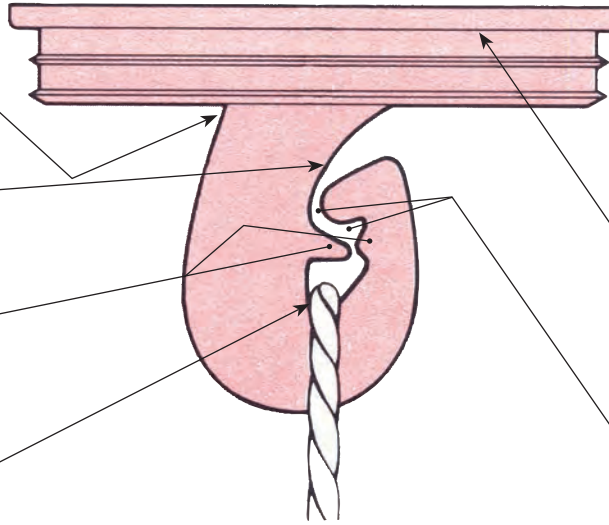

### 5. EXTRA HOLDING POWER

Ribbed nylon exerts additional pressure to hold finished buttons together.

### 6. IT'S STRONGER

Extra high impact nylon, solid one-piece, for added strength.

### 7. HOLDS TIGHTER

Grooved rim helps hold material and shell tight to the collet. Great for vinyl. Puts the stop on pop-offs.

### 8. WON'T WORK LOOSE

Double lock channels further restrict loop from ever ridding up.



NYLON SUPER HOOK 5 GROSS BOX.				
Osborne No.	WPSH22-5	WPSH30-5	WPSH36-5	WPSH45-5
Button size	22	30	36	45
UPC No.	77116	77128	77144	77156



Also available in 1, 25 or 50 gross box.

## NYLON POLY WASHER FOR SUPER HOOK



Ideal washer for super hook buttons. It has one inch diameter. Great holding power. Available in 1, 25 and 50 gross box.

POLY WASHER FOR SUPERHOOK		
Osborne No.	WWAP138-1	WWAP138-5
Diameter	1-3/8	1-3/8
UPC No.	74747	74748

Also available in 25 & 50 gr. boxes.

## UNASSEMBLED NAIL

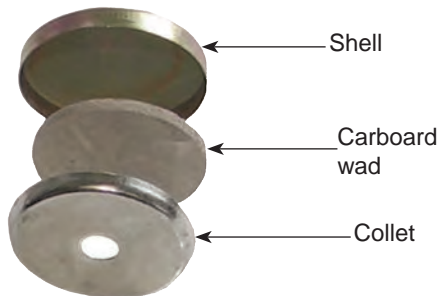

ADVANTAGES: Costs, less than a pre-assembled nail. You supply the nail or tack of your choice.

COVERING OPERATION: Collet (button back) is placed in die. Nail (or tack) is inserted through hole in collect. Cardboard Wad is place on top of the nail. Covering is then completed in the usual manner. Sold as combination (shells, carboard wad and collect) or individually.

UNASSEMBLED NAIL COMBINATION 5 GROSS BOX			
Osborne No.	WCM22COCWSS5GR	WCM30COCWSS5GR	WCM36COCWSS5GR
Button size	22	30	36
UPC No.	73226	73090	73226
Osborne No.	WCM40COCWSS5GR	WCM45COCWSS5GR	
Button size	40	45	
UPC No.	73166	73180	

INDIVIDUAL COMPONENTS ARE ALSO SOLD SEPARATELY



**COMBOS**

**PRONG WITH SOFT SHELL 5 GROSS BOX. (ALSO AVAILABLE IN 1 GROSS BOX)**

<b>Osborne No.</b>	WCM22112PRSS5GR	WCM222PRSS5GR	WCM22212PRSS5GR	WCM242PRSS5GR	WCM24212PRSS5GR
<b>Size &amp; length</b>	22 1-1/2"	22 2"	22 2-1/2"	24 2"	24 2-1/2"
<b>UPC No.</b>	75036	75084	75064	75180	75168
<b>Osborne No.</b>	WCM30112PRSS5GR	WCM302PRSS5GR	WCM30212PRSS5GR	WCM303PRSS5GR	WCM36112PRSS5GR
<b>Size &amp; length</b>	30 1-1/2"	30 2"	30 2-1/2"	30 3"	36 1-1/2"
<b>UPC No.</b>	75240	75292	75272	75328	75404
<b>Osborne No.</b>	WCM362PRSS5GR	WCM36212PRSS5GR	WCM40112PRSS5GR	WCM402PRSS5GR	WCM452PRSS5GR
<b>Size &amp; length</b>	36 2"	36 2-1/2"	40 1-1/2"	40 2"	45 2"
<b>UPC No.</b>	75428	75420	75512	75520	75572

**THREADED NAIL WITH SOFT SHELL 5 GROSS BOX. (ALSO AVAILABLE IN 1 GROSS BOX)**

<b>Osborne No.</b>	WCM2278TNSS5GR	WCM22212TNSS5GR	WCM222TNSS5GR	WCM2478TNSS5GR	WCM3078TNSS5GR
<b>Size &amp; length</b>	22 7/8"	22 2-1/2"	22 2"	24 7/8"	30 7/8"
<b>UPC No.</b>	75140	75048	75092	74034	75352
<b>Osborne No.</b>	WCM30112TNSS5GR	WCM302TNSS5GR	WCM3678TNSS5GR	WCM36112TNSS5GR	WCM362TNSS5GR
<b>Size &amp; length</b>	30 1-1/2"	30 2"	36 7/8"	36 1-1/2"	36 2"
<b>UPC No.</b>	75252	75308	75472	75412	75440

**NO DENT NAIL WITH SOFT SHELL 5 GROSS BOX. (ALSO AVAILABLE IN 1 GROSS BOX)**

<b>Osborne No.</b>	WCM2234NDSS5GR	WCM2278NDSS5GR	WCM221NDSS5GR	WCM3034NDSS5GR	WCM301NDSS5GR
<b>Size &amp; length</b>	22 3/4"	22 7/8"	22 1"	30 3/4"	30 1"
<b>UPC No.</b>	75104	75132	74010	75320	75256
<b>Osborne No.</b>	WCM30114NDSS5GR	WCM30112NDSS5GR	WCM3634NDSS5GR	WCM361NDSS5GR	WCM451NDSS5GR
<b>Button size</b>	30 1-1/4"	30 1-1/2"	36 3/4"	36 1"	45 1"
<b>UPC No.</b>	75259	75228	75448	74074	74100

**NYLON SUPER HOOK WITH SOFT SHELLS 5 GR. BOX (ALSO AVAILABLE IN 1 GROSS BOX)**

<b>Osborne No.</b>	WCM22SHSS5GR	WCM30SHSS5GR	WCM36SHSS5GR	WCM45SHSS5GR
<b>Button size</b>	22	30	36	45
<b>UPC No.</b>	75160	75396	75504	75616

**NYLON SNAP RINGS SOFT SHELLS 5 GR. BOX (ALSO AVAILABLE IN 1 GROSS BOX)**

<b>Osborne No.</b>	WCM30PSRSS5GR	WCM36PSRSS5GR
<b>Button size</b>	30	36
<b>UPC No.</b>	75392	75496

**COMBOS ALSO AVAILABLE WITH ALUMINUM SHELLS AND RUST RESISTANT. SPECIFY WHEN ORDERING**

## TUFTING NEEDLES & CLASPS

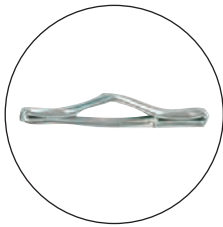
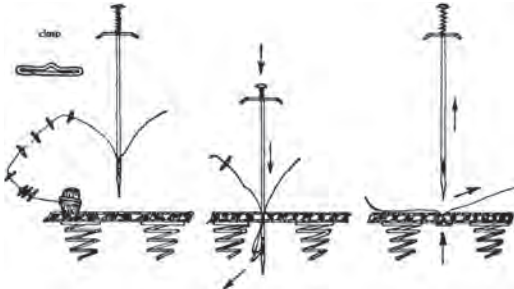

CLASPS

### Osborne No. 417

THE VERY BEST. Does not catch when needle is withdrawn. After threading button, end of needle is loaded with clasp. As needle reaches maximum depth, clasp is ejected. Saves time and labor. No need to remove the outside back of piece being tufted. A splendid tool to the true craft person.

Working Process:

- 1.- At the start, assemble on the thread the corresponding quantity of clasps for the required number of stitches. Insert clasp with thread in the hollow of the needle.
- 2.- Push needle (with inserted clasps and thread) through upholstery fabric, press head of needle. Clasp with thread will be ejected.
- 3.- Pull needle out and tighten thread, clasp will be anchored inside.

Needles are carded with instructions included.

### Osborne No. 417-L

Same as our popular Osborne No. 417 but 18 inches in length and well suited for mattresses.

Osborne No.	Overall length (inches)	Weight (oz)	UPC No.
417	12	3	64386
417-L	18	5	64388

### Osborne No. 418

High quality. These clasps are used with our Osborne No. 417 & 417-L Tufting Needles. Packed and sold in boxes of 500 pcs.

Quantity per box	Weight/box (oz)	UPC No.
500	10	14388

## TUFTING NEEDLE & CLASPS

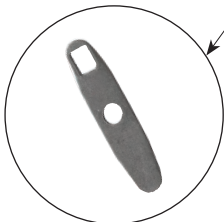
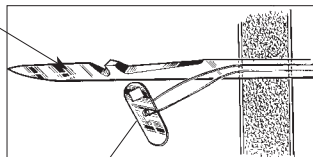

### Osborne No. 613

Nickel plated. Furniture button tufter comes with two dozen clasps. Osborne quality needle. Thread twine in round hole of clasp, hook square hole on needle and push then withdraw needle. Directions included.

Overall length (inches)	Gauge	Weight (oz)	UPC No.
12	10	2	64390

### Osborne No. 614

High quality steel. These clasps are used with our Osborne No. 613 Tufting Needle. Packed and sold in bags of 144 pcs.

Quantity per bag	Weight/box (oz)	UPC No.
144	3	14392



**MATTRESS BUTTON TUFTER**



**Osborne No. 414**

Nickel plated. Thread button on cord, cut to length. Push needle through mattress until cord ends come through. Pull out needle. Repeat on all buttons. Then turn over mattress and tie. 2 lengths are available.

Osborne No.	Overall length (inches)	Gauge	Weight ea. (oz)	UPC No.
<b>414-12</b>	12	11	1	64372
<b>414-14</b>	14	11	1	64374

**LOOP NEEDLE**



**Osborne No. 615**

Loop needle with a 1/2" slot to hold pre-tied loops. Also used for hand tufting with pretied nylon loops. Available in 11" and 17". Please specify length when ordering.

Osborne No.	Overall length (inches)	Slot (inches)	Weight (oz)	UPC No.
<b>615-11</b>	11	1/2	2	14394
<b>615-17</b>	11	1/2	3	14396

**"T" HANDLE TUFTING TOOL**



**Osborne No. 408**

High quality Osborne tufting tool. Made of hardened steel with rubber handle. Used for pulling loops through or up.

Overall length (inches)	Weight (oz)	UPC No.
10 1/2	3	64342

**PRONG BUTTON TUFTER**

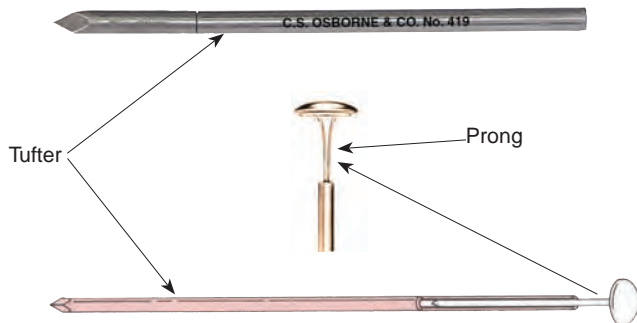

**Osborne No. 419**

The Osborne No. 419 Prong Button Tufter accepts any length of prong 22 to 45 size of button. Tool is withdrawn after piercing fabric leaving the prongs extended through the fabric. This keeps the prongs from spreading while being put through the padding.

Overall length (inches)	Weight (oz)	UPC No.
5 1/2	2	64398

Prong is inserted into hollow end of needle. Needle is pushed through construction and withdrawn, leaving prong extended.

## MONOFILAMENT THREAD



### Osborne No. 4705

A clear nylon thread. Blends in with fabric being sewn and is very strong. 3 sizes available.

**No. 18** very light thread is for bar tacking, quilting, etc.

**No. 40** is for general upholstery work, canvas, etc.

**No. 52** extra heavy duty thread for heavy fabric, canvas, etc.

Pack and sold in individual canisters.

Osborne No.	Gauge	Breaking strength (lbs.)	Approximate yards per roll	Weight per canister (lbs)	UPC No.
<b>4705-18</b>	39	1-1/2	23,900	4	78336
<b>4705-40</b>	33	3-1/2	10,600	6	78340
<b>4705-52</b>	32	7-1/2	8,600	8	78344

## NYLON TUFTING TWINE



### Osborne No. 4700

Made of superior quality white nylon. This twine has high tensile strength required for holding buttons in place. Available in 1/2 or 2 lbs. rolls.

Osborne No.	Description	Gauge	Yards per tube	UPC No.
<b>4700-T1/2</b>	1/2 lb. tube	9	350	78308
<b>4700-T2</b>	2 lb. tube	9	1400	78312

## UPHOLSTERER'S REGULATOR - With Eye



### Osborne No. 306-1/2

High quality steel. Available in 3 thickness and variety of lengths. Packed and sold by dozen only.

Extra light			Light			Heavy		
Size No.	Gauge	UPC No.	Size No.	Gauge	UPC No.	Size No.	Gauge	UPC No.
6	10	16052	6	9	16032	6	6	16042
8	10	16054	8	9	16034	8	5	16044
10	10	16056	10	8	16036	10	5	16046
			12	7	16038	12	5	16048

## UPHOLSTERER'S REGULATOR - With Plastic Handle



### Osborne No. 520

High quality steel. Plastic handle. Available in 4 sizes.

Size No.	Overall length (inches)	Gauge	Weight each (oz)	UPC No.
6	6	10	1	66062
8	8	10	1	66064
10	10	10	2	66066
12	12	10	2	66068

## UPHOLSTERER'S REGULATORS

No. 527



No. 528



### Osborne No. 527 & 528

Extra sturdy construction to last years and years. High quality steel. Hex stock handle. The only difference is that one has a flattened round head and the other a flattened diamond head.

Osborne No.	Hex stock (inches)	Overall (inches)	Type of head	Weight (oz)	UPC No.
<b>527</b>	3/8	9	Round	3	66070
<b>528</b>	3/8	9	Diamond	3	66072

### GROMMET DIES & HOLE CUTTER FOR W-1 & W-3

3 pc. set. These grommet dies work with our W-1 Hand Press or W-3 Pneumatic machines. Dies available for PLAIN or SPUR grommets from 3/16" up to 2". Sold in sets with hole cutter. Instructions enclosed.

#### 2 PC. DIES & HOLE CUTTER FOR GROMMETS WITH PLAIN WASHERS

Osborne No.	WDIGRC00	WDIGRC0	WDIGRC1	WDIGRC2	WDIGRC3	WDIGRC4	WDIGRC5	WDIGRC6	WDIGRC12	WDIGRC15
Size	00	0	1	2	3	4	5	6	12	15
Hole (inches)	3/16	1/4	9/32	3/8	7/16	1/2	5/8	13/16	1-9/16	2
UPC No.	75850	75854	75858	75861	75869	75873	75877	75883	75881	75889



#### 2 PC. DIES & HOLE CUTTER FOR GROMMETS WITH SPUR WASHERS

Osborne No.	WDISGR0	WDISGR1	WDISGR2	WDISGR3
Size	0	1	2	3
Hole (inches)	1/4	5/16	3/8	7/16
UPC No.	75831	75835	75837	75839
Osborne No.	WDISGR4	WDISGR5	WDIGRC10	
Size	4	5	10	
Hole (inches)	9/16	5/8	1-1/2	
UPC No.	75841	75843	75885	



Our Osborne No. W-1 Hand Press Machine also sets SNAPS & VENTILATORS.



### SNAP DIES FOR W-1 & W-3

4 pc. set. These dies are used for setting four piece snaps size 20 (baby 1/2") or size 24 (standard 5/8"). These dies work with our W-1 Hand Press or W-3 Pneumatic machines. Full instructions enclosed.

Osborne No.	Description	UPC No.
<b>WDISN201</b>	4 pc. dies for standard snaps 1/2"	76278
<b>WDISN41</b>	4 pc. dies for standard snaps 5/8"	76284

### SELF PIERCING GROMMET DIES FOR W-1 & W-3

2 pcs. set. No cutter needed. Blued finish to help prevent corrosion. Top die retains grommet from falling when been set. 4 sizes available.



Osborne No.	Description	UPC No.
<b>WDISP0</b>	Self piercing setting die set for 1/4" grommet	75862
<b>WDISP1</b>	Self piercing setting die set for 5/16" grommet	75863
<b>WDISP2</b>	Self piercing setting die set for 3/8" grommet	75864
<b>WDISP3</b>	Self piercing setting die set for 7/16" grommet	75865

### JEAN RIVET DIES

CNC Machined. 2 pcs. set used with our Hand Press W-1 to install Jeans Rivets. Full instructions provided.



Osborne No. WDIRI21

### VENTILATOR DIES & HOLE CUTTER FOR W-1 & W-3

3 pc. set. Precision machined. High quality steel. Set composed of 2 pc. die and hole cutter. Sets 3/4" of 1" vents. These dies work with our W-1 Hand Press or W-3 Pneumatic machines. Full instructions provided.

Osborne No.	Description	UPC No.
<b>WDIVC3/4</b>	Die & hole cutter for 3/4" ventilator	76300
<b>WDIVC1</b>	Die & hole cutter for 1" ventilator	76292



Osborne grommet inserting dies and grommet hole cutters are numbered to correspond with standard size grommets. The dies are guaranteed to set the proper size and style Osborne grommets. Grommet dies and cutters should be used with an Osborne rawhide hammer or wooden mallet, not with a steel hammer. We recommend our No. 395 rawhide hammers for this purpose.

### PLAIN GROMMET INSERTING DIE



Male sits flat on base.

### Osborne No. 216

Sets **plain rim grommets and washers**. Sizes 00 thru 5 are CNC machined from high grade tool steel, while sizes 6 & up are a malleable iron casting. Properly machined and hardened. The finest industrial grommet dies made. For best results use only Osborne grommets and washers G1, B1, N1 & SS1 with corresponding sizes.

Size No.	Weight each (lbs)	(oz)	UPC No.	Size No.	Weight each (lbs)	(oz)	UPC No.
00	1	6	13212	5	2	10	13224
0	1	6	13214	6	3	15	13226
1	1	7	13216	8	3	16	13230
2	1	7	13218	10	3	10	13232
3	1	9	13220	11	4	15	13234
4	2	8	13222	15	5	15	13236

### SPUR GROMMET INSERTING DIE



Male sits higher on base. This gap prevents teeth on spur grommets from getting crushed when set.

### Osborne No. 217

Sets **rolled rim grommets & spur washers**. Sizes 0 thru 5 CNC machined from high grade tool steel, while sizes 6 & up are a malleable iron casting. Properly machined and hardened. The finest industrial grommet dies made. For best results use only Osborne grommets and washers G2, N2 & B2 with corresponding sizes.

Size No.	Weight each (lbs)	(oz)	UPC No.	Size No.	Weight each (lbs)	(oz)	UPC No.
0	1	6	13244	5	2	10	13254
1	1	7	13246	6	3	15	13256
2	1	7	13248	7	4	6	13258
3	1	9	13250	8	5	8	13260
4	2	8	13252	10	7	8	13262

### STAINLESS STEEL GROMMET INSERTING DIE



### Osborne No. 215

Sets **plain rim stainless grommets and washers** series No. SS. Sizes 00 thru 4 are CNC machined from special steel designed for strong stainless grommets.

Size No.	Weight each (lbs)	(oz)	UPC No.	Size No.	Weight each (lbs)	(oz)	UPC No.
00	1	6	13200	2	1	7	13206
0	1	6	13202	3	1	9	13208
1	1	7	13204	4	1	9	13210

### GROMMET HOLE CUTTER



### Osborne No. 500 & K-500

Use with corresponding sizes of grommets and setting dies. Drop forged, hardened and polished edge. Inside tapered for easy clearance. Kit also available with popular sizes No. K-500.



#### K-500 Kit

- 1/2"
- 7/16"
- 3/8"
- 9/32"
- 1/4"
- 3/16"

Size No.	00A	0A	1A	2A	3A	4A	5A	6A	7A	8A
Hole size (in)	3/16	1/4	9/32	3/8	7/16	1/2	5/8	3/4	7/8	1
Weight ea. (oz)	2	2	3	3	6	6	9	9	12	13
UPC No.	51610	51612	51614	51616	51618	51620	51622	51624	51626	51628





For best results in setting our plain rim grommets and washers, use an **Osborne No. 500** hole punch and an **Osborne No. 216** setting die with corresponding sizes. Also can be set using W-1 & W-3 Machines. Sizes 00 to 6 are packed in 1 gross boxes.

## PLAIN RIM GROMMETS AND WASHERS

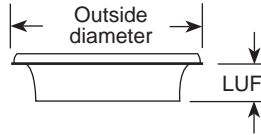

### Osborne No. G1 & N1 & B1

Sizes 00 to 6 available in BRASS, NICKEL & DULL BLACK finish. Material is brass. 144 pcs. per box.

### Osborne No. SS

STAINLESS STEEL. Sizes 00 to 4 available. 144 pcs. per box.



**G1 - BRASS**



**N1 - NICKEL**



**B1 - DULL BLACK**



**SS - STAINLESS STEEL**

Size No.	Diameter of hole when set (inches)	Outside diameter (inches)	Length under flange (inches)	Weight/box (lbs) (oz)	BRASS UPC No.	NICKEL UPC No.	BLACK UPC No.	STAINLESS UPC No.
00	3/16	0.460	0.135	- 2	13012	13112	71884	72880
0	1/4	0.546	0.175	- 5	13014	13114	71882	72882
1	9/32	0.700	0.185	- 8	13016	13116	71886	72884
2	3/8	0.835	0.215	- 12	13018	13118	71888	72886
3	7/16	0.955	0.295	1 2	13020	13120	71890	72888
4	1/2	1.062	0.374	1 8	13022	13122	71892	72890
5	5/8	1.205	0.330	1 12	13024	13124	71894	N/A
6	13/16	1.828	0.232	6 -	13026	13126	71896	N/A

For best results in setting our ROLLED rim grommets and SPUR washers, use an **Osborne No. 500** hole punch and an **Osborne No. 217** setting die with corresponding sizes. Also can be set using W-1 & W-3 Machines. Sizes 00 to 6 are packed in 1 gross boxes.

## ROLLED RIM GROMMETS AND SPUR WASHERS

### Osborne No. G2, N2 & B2

Sizes 0 to 8 available in BRASS, NICKEL and DULL BLACK finish. Material is brass. 144 pcs. per box.



**G2 - BRASS**



**N2 - NICKEL**



**B2 - DULL BLACK**

Size No.	Diameter of hole when set (inches)	Outside diameter (inches)	Length under flange (inches)	Weight/box (lbs) (oz)	BRASS UPC No.	NICKEL UPC No.	BLACK UPC No.
0	9/32	0.645	0.175	- 13	13044	13144	13344
1	13/32	0.790	0.205	1 2	13046	13146	13346
2	7/16	0.890	0.215	1 10	13048	13148	13348
3	15/32	0.970	0.255	2 4	13050	13150	13350
4	9/16	1.120	0.320	2 4	13052	13152	13352
5	5/8	1.270	0.380	3 8	13054	13154	N/A
6	3/4	1.505	0.420	5 10	13056	13156	N/A
7	29/32	1.725	0.446	5 10	13058	13158	N/A
8	1 3/32	1.910	0.465	8 2	13060	13160	N/A

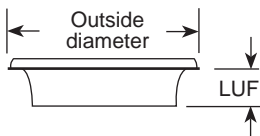



## SELF PIERCING GROMMETS & WASHERS

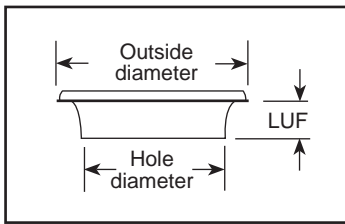

### Osborne No. G3 & N3

Made of heavier gauge brass compared to traditional sheet metal grommets.

Pierce and set in a single action. No need to prepunch the hole. These grommets are install only using our Hand Press Machine Osborne No. W-1 or our W-3 Pneumatic Machine using the appropriated dies listed on page 53.

Available in 4 sizes with BRASS or NICKEL finish.

Packed and sold in 500 pcs. per box.

Osborne No.	Finish	Hole Diameter (in)	Outside Diameter (in)	L.U.F. (in)	UPC No.
G3-0	Brass	1/4	0.550	0.165	13064
G3-1	Brass	5/16	0.630	0.200	13066
G3-2	Brass	3/8	0.750	0.320	13068
G3-3	Brass	7/16	0.970	0.185	13070
N3-0	Nickel	1/4	0.550	0.165	13164
N3-1	Nickel	5/16	0.630	0.200	13166
N3-2	Nickel	3/8	0.750	0.320	13168
N3-3	Nickel	7/16	0.970	0.185	13170

## OVERSIZED GROMMETS



\* G2-10 & N2-10 are spur  
LUF = Length under flange

These **LARGE GROMMETS** are installed with our Osborne No. W-1 Hand Press Machine or W-3 Pneumatic Machine using their correspondent grommet dies. Available in 3 sizes. Packed and sold in boxes of 20 sets. Size 10 is SPUR, 12 & 15 are PLAIN. Mostly used on draperies. Size 12 & 15 also available in black and antique color.

Osborne No.	Finish	Whole diameter (inches)	Outside diameter (inches)	LUF (inches)	Weight/box (lbs) (oz)	UPC No.
G2-10	* BRASS	1-1/2	2.36	0.355	1 - 3	13062
N2-10	* NICKEL					13162
A1-12	ANTIQUE	1-9/16	2.453	0.360	1 - 5	71878
B1-12	BLACK					71880
G1-12	BRASS					71874
N1-12	NICKEL					71876
A1-15	ANTIQUE	2	3.135	0.420	1 - 6	71879
B1-15	BLACK					71881
G1-15	BRASS					71872
N1-15	NICKEL					71877

## MIDGET GROMMET DIE



### Osborne No. 235

For setting plain rim washers and grommets. For home use or hobbyist.

Size No.	Weight ea. lbs.	UPC No.	Size No.	Weight ea. lbs.	UPC No.
00	1	13272	3	1 1/4	13280
0	1	13274	4	1 1/4	13284
1	1	13276	5	1 3/4	13286
2	1 1/4	13278	6	1 3/4	13288

## SET-IT-YOURSELF GROMMET KITS



### Osborne No. K234 (With brass plain grommets)

Hang up display card is packed in an easy to use DISPLAY BOX. Complete instructions on back of card. Kit includes: one wood block, one hole cutter, one setting die and brass grommets and plain washers. Available in 6 sizes listed below. Card measures 6-7/8" x 9-3/4".

### Osborne No. K231 (With nickel plain grommets)

Similar to our Osborne No.K234 series but with nickel finish grommets and plain washers. Cards measures 6-7/8" x 9-3/4".

### Osborne No. K233 (With dull black plain grommets)

Similar to our Osborne No.K234 series but with dull black grommets and plain washers. Cards measures 6-7/8" x 9-3/4".

Size No.	Hole size (inches)	Grommets per card	Weight ea. (oz.)	K231 UPC No.	K233 UPC No.	K234 UPC No.
00	3/16	4 dozen	14	13306	13306	13318
0	1/4	4 dozen	14	13308	13308	13320
1	9/32	4 dozen	15	13310	13310	13322
2	3/8	2 dozen	17	13312	13312	13324
3	7/16	2 dozen	18	13314	13314	13326
4	1/2	2 dozen	19	13316	13316	13328

## GROMMET PRESS - Portable Grommets & Snaps Setter

### Osborne No. W-50

Made of light weight aluminum construction. Easy to use and carry. Sets snaps, grommets. No need for table or hammer to set. Screw action. It works with self piercing grommet dies, regular dies and snaps dies and also sets ventilators and rapid rivets which dies are sold separately. (not included). It can set up to size # 4 grommets with ease.

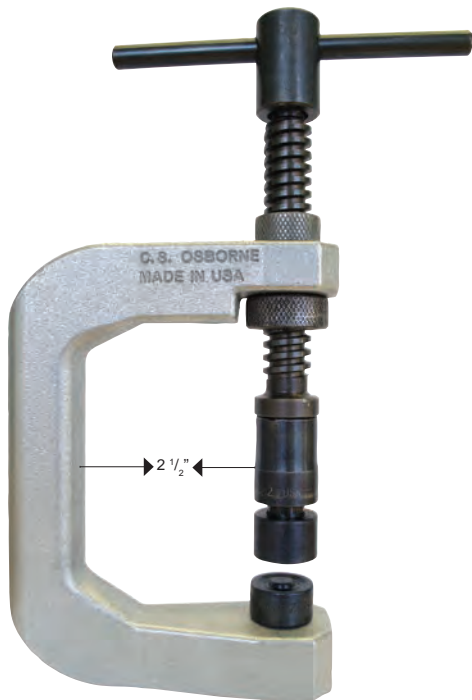

Overall height (inches)	Distance A (inches)	Weight (lbs.) (oz.)	UPC No.
11	2-1/2	2 8	76286



Plain Grommet Dies



Spur Grommet Dies



Ventilator Dies



Snap Dies



Self Piercing Grommet Dies



Rivet Dies

## HOME GROMMET KITS



### Osborne No. K235

A complete and affordable kit for consumer use. Each kit consists of a No. 235 grommet die, a No. 245 cutting punch, **brass** plain rim grommets and washers, a small cutting board and complete instructions. Sizes 5 and 6 have 18 grommets.

### Osborne No. K232

Same as the K235 series but with **plain rim nickel finish** grommets. Same sizes and packaging.

Size No.	Hole size (inches)	Grommets per card	Weight ea. (oz.)	K235 UPC No.	K232 UPC No.
00	3/16	3 dozen	14	13293	13264
0	1/4	3 dozen	14	13294	13263
1	9/32	3 dozen	15	13296	13265
2	3/8	3 dozen	17	13298	13266
3	7/16	3 dozen	18	13300	13267
4	1/2	3 dozen	19	13302	13268
5	5/8	18 ea.	22	13304	13270
6	13/16	18 ea.	24	13305	13271

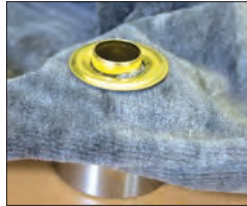

## GROMMET KITS



### Osborne No. K257-00

Kit includes Osborne No. 257-00 Grommet Setting Plier, No. 245 Hole Punch and one gross of grommets No. G1-00. This kit sets 3/16" hole diameter grommets. Carded for display purposes.

Overall length (inches)	Card (inches)	Weight (oz.)	UPC No.
8	11 x 4	12	13292

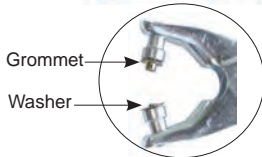

Refills also available  
**Osborne No. G1S, N1S,  
& B1S**

### Osborne No. K257N-00

This grommet kit is similar to Osborne No. K257-00 but with **nickel** finish grommets. Also carded for display purposes. UPC No. 13295.

## GROMMETS REFILLS

### Osborne No. G1S, N1S, B1S & SS1S

Plain rim grommets refills for our Grommet Kits Osborne No. K235 & K232. Available in **BRASS** finish Osborne No. G1S, **NICKEL** Osborne No. N1S, **DULL BLACK** Osborne No. B1S. and **STAINLESS STEEL** Osborne No. SS1S. Packaged in hang up display bags.



Size No.	Grommets per bag	G1S UPC No.	N1S UPC No.	B1S UPC No.	SS1S UPC No.
00	24	12998	13005	71862	81860
0	24	13000	13032	71860	81862
1	24	13001	13006	71864	81864
2	24	13002	13007	71866	81866
3	24	13003	13008	71868	81878
4	24	13004	13009	71870	81870

**SNAP-FASTENER KIT**



**Osborne No. K230-20 & K230-24**

An easy to use hand snap set. Snaps are nickel plated brass. Available in two sizes: # 20 baby snaps 1/2" or # 24 standard 5/8" snaps Kit includes 25 complete snaps, flaring tool, two dies (concave and stud) a bracket and instructions.

Osborne No.	Description	Weight ea. (oz.)	UPC No.
<b>K230-20</b>	# 20 Snap set kit	3	14231
<b>K230-24</b>	# 24 Snap set kit	3	14228

**SNAP-FASTENER KIT**



**Osborne No. 230-SET 20 & 230-SET 24**

3 pc. setter only. No snaps are included. Available for line # 20 (1/2" baby snaps) and line # 24 (standard 5/8" snaps).

Osborne No.	Description	Weight ea. (oz.)	UPC No.
<b>230-SET 20</b>	# 20 snap setter only	2	14234
<b>230-SET 24</b>	# 24 snap setter only	2	14236

**SNAP-FASTENER KIT**



**Osborne No. K229-20 (Baby Snaps)  
Osborne No. K229-24 (Standard Snaps)**

Includes parts to complete six 1/2" baby snaps or 5/8" standard nickel plated brass snaps along with flaring tool and die. Instructions printed on back of hang up card 4 3/4" x 5 3/4".

Osborne No.	Snap diameter (inches)	Weight ea. (oz.)	UPC No.
<b>K229-20</b>	1/2	3	14230
<b>K229-24</b>	5/8	3	14232

**DURABLE SNAP SETTER**



**Osborne No. 229**

**Osborne No. 229-20** - Setting die for #20 Baby Dot snaps.  
**Osborne No. 229-24** - Setting die for #24 Standard snaps.  
Comes with flaring tool, a double-sided die and instructions.

Osborne No.	Snap diameter (inches)	Weight (oz.)	UPC No.
<b>229-20</b>	1/2	3	17282
<b>229-24</b>	5/8	3	17284

**CUTTERS**

Time-saving tools designed for Manufacturers and Fabricators of marine covers, auto tops, awnings, canvas products, cockpit covers and industrial fabrics. Vinyl handles to add comfort. Yellow zinc plated frame.

**Turn Button Cutter  
Osborne No. 4100**



8-1/2" overall  
Weight: 1lb. 9 oz.  
UPC No. 79000

**Curtain Fastener Cutter  
Osborne No. 4000**



8-1/2" overall  
Weight: 1lb. 6 oz.  
UPC No. 79100

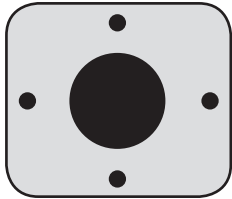

← ACTUAL SIZE OF PUNCH PATTERN

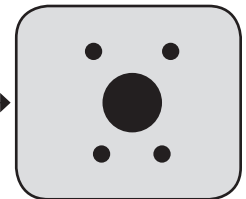

← ACTUAL SIZE OF PUNCH PATTERN

**PLIER-ACTION HOLE CUTTERS PUNCH MATERIAL WHEN SETTING TURN BUTTONS AND CURTAIN FASTENERS**

**FASTENERS**

**Osborne No. K4110  
Turn Buttons**

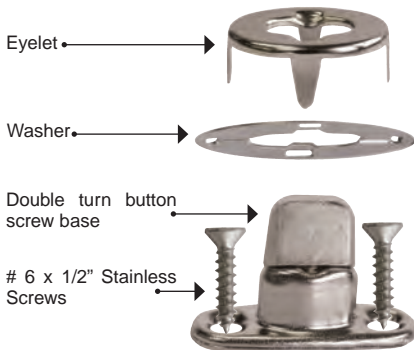

Osborne No.	Description	Weight (oz.)	UPC No.
<b>K-4110</b>	Turn Buttons Kit - 25 sets	12	14265
<b>K-4010</b>	Curtain Fasteners Kit - 25 sets	8	14263

**Osborne No. K4010  
Curtain Fastener**

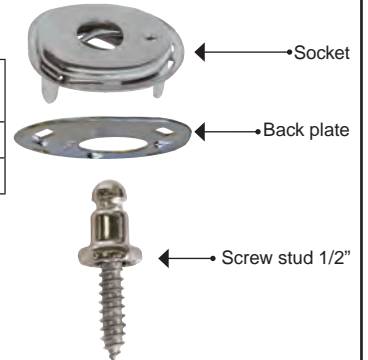

## CURTAIN FASTENER HAND PUNCH



### Osborne No. 4020

CNC machined from high carbon steel. Sharpened cutters. Similar to our popular No. 4000 Cutter but used with a hammer. Blued finish to prevent any corrosion. Used for curtains fasteners.

Overall (inches)	Weight (oz.)	UPC No.
4 1/2	12	79010

## TURN BUTTON HAND PUNCH



### Osborne No. 4120

CNC machined from high carbon steel. Sharpened cutters. Similar to our popular No. 4100 Cutter but used with a hammer. Blued finish to prevent any corrosion. Used for turn buttons.

Overall (inches)	Weight (oz.)	UPC No.
4 1/2	12	79002

## FIT RIGHT COVER KIT



Socket Pin



Plastic Gap



Unsnapping Tool

### Osborne No. K4500

Kit includes: 50 socket pins, 25 plastic gap, 1 unsnapping tool. Individual parts also sold separately.

Osborne No.	K-4500	4500-SP	4500-PC	4500-UT
<b>Descriptor</b>	Kit	Socket Pin	Plastic Gap	Tool
<b>Weight (oz)</b>	5	3	3	2
<b>Pcs/box</b>	1	50	50	6
<b>UPC No.</b>	79014	79016	79018	79020

## CURTAIN FASTENER DRIVER



### Osborne No. 4030

Nickel plated. Fluted amber cellulose acetate handle to keep from rolling. Used to install 3/8" hex screw studs.

Overall (inches)	Weight (oz.)	UPC No.
6 1/2	4	79012

## TURN BUTTON DRIVER



### Osborne No. 4130

Nickel plated. Fluted amber cellulose acetate handle to keep from rolling. Used to install turn button screws.

Overall (inches)	Weight (oz.)	UPC No.
6 1/2	3	79006

## PRONG FOLDING TOOL



### Osborne No. 4150

Fluted amber cellulose acetate handle to keep from rolling. Concave end. Used to fold the legs of eyelets, prongs, studs and sockets.

Overall (inches)	Weight (oz.)	UPC No.
6	3	79008

## PRONG FOLDING TOOL



### Osborne No. 4140

Sharp points. Carbon steel hardened and tempered. Cuts slits for prong studs for both fasteners. Blued finish to prevent any corrosion.

Overall (inches)	Weight (oz.)	UPC No.
3 1/2	4	79004



## SNAPS FASTENERS

1/4" post height.  
Also available  
in 3/8".



1/4" post height.  
Also available  
in 3/8".

MATERIAL	FINISHES				
Brass & Steel	Nickel plated	Enamel black	Shiny brass	Copper black	Antique
Stainless Steel	Stainless				
SIZES	# 20 (BABY SNAPS 1/2") & # 24 (STANDARD SNAPS 5/8")				
PACKAGED	100 pcs per box = C or 1,000 pcs. per box = M				

**SOLD PER SETS  
OR BY INDIVIDUAL  
PARTS**

### SETS (COMPLETE 4 PARTS)

OSBORNE No.	Size	Material	Finish	Pcs.	UPC No.		
K1708-11-C	20	STAINLESS STEEL	STAINLESS STEEL	100	14196		
K1708-11-M				1,000	14198		
K2708-11-C				BRASS	NICKEL PLATED	100	14200
K2708-11-M						1,000	14202
K2713-16-C		COPPER BLACK	100			14204	
K2713-16-M			1,000			14206	
K2717-20-C			SHINY BRASS	100	14208		
K2717-20-M				1,000	14210		
K3708-11-C		STEEL		NICKEL PLATED	100	14212	
K3708-11-M					1,000	14214	
K3713-16-C			COPPER BLACK		100	14216	
K3713-16-M					1,000	14218	
K3717-20-C		SHINY BRASS		100	14220		
K3717-20-M				1,000	14222		
K3721-24-C			ANTIQUE	100	14256		
K3721-24-M				1,000	14258		
K4708-11-C		24		BRASS	NICKEL PLATED	100	14235
K4708-11-M						1,000	14237
K4908-11-C			NICKEL PLATED XL Cap & Eyelet			100	14243
K4908-11-M						1,000	14246
K4713-16-C	COPPER BLACK			100	14238		
K4713-16-M				1,000	14239		
K4717-20-C			SHINY BRASS	100	14240		
K4717-20-M				1,000	14241		
K4721-24-C	STEEL			ANTIQUE	100	14252	
K4721-24-M					1,000	14254	
K5708-11-C			NICKEL PLATED		100	14245	
K5708-11-M					1,000	14247	
K5713-16-C	COPPER BLACK			100	14248		
K5713-16-M				1,000	14249		
K5717-20-C			SHINY BRASS	100	14250		
K5717-20-M				1,000	14251		
K6708-11-C	STAINLESS STEEL			STAINLESS STEEL	100	14260	
K6708-11-M					1,000	14262	

### INDIVIDUAL PARTS

OSBORNE No.	Size	Part	Material	Finish	Pcs.	UPC No.			
1708-C	20	Eyelet	STAINLESS STEEL	STAINLESS STEEL	100	67286			
1708-M					1,000	67288			
1709-C		Cap			100	67290			
1709-M					1,000	67292			
1710-C		Socket			100	67294			
1710-M					1,000	67296			
1711-C		Stud			100	67298			
1711-M					1,000	67300			
2708-C		20			Eyelet	BRASS	NICKEL PLATED	100	40002
2708-M								1,000	40004
2709-C	Cap		100	40008					
2709-M			1,000	40010					
2710-C	Socket		100	40014					
2710-M			1,000	40016					
2711-C	Stud		100	40020					
2711-M			1,000	40022					
2713-C	20		Eyelet	BRASS	COPPER BLACK			100	40026
2713-M								1,000	40028
2714-C		Cap	100			40032			
2714-M			1,000			40034			
2715-C		Socket	100			40038			
2715-M			1,000			40040			
2716-C		Stud	100			40044			
2716-M			1,000			40046			
2717-C		20	Eyelet			BRASS	SHINY BRASS	100	40050
2717-M								1,000	40052
2718-C	Cap		100	40056					
2718-M			1,000	40058					
2719-C	Socket		100	40062					
2719-M			1,000	40064					
2720-C	Stud		100	40068					
2720-M			1,000	40070					
2721-C	20		Eyelet	BRASS	ANTIQUE			100	50000
2721-M								1,000	50002
2722-C		Cap	100			50004			
2722-M			1,000			50006			
2723-C		Socket	100			50008			
2723-M			1,000			50010			
2724-C		Stud	100			50012			
2724-M			1,000			50014			
3708-C		20	Eyelet			STEEL	NICKEL PLATED	100	40074
3708-M								1,000	40076
3709-C	Cap		100	40080					
3709-M			1,000	40082					
3710-C	Socket		100	40086					
3710-M			1,000	40088					
3711-C	Stud		100	40092					
3711-M			1,000	40094					





OSBORNE No.	Size	Part	Material	Finish	Pcs.	UPC No.
3713-C	20	Eyelet	STEEL	COPPER BLACK	100	40098
3713-M					1,000	40100
3714-C		Cap			100	40104
3714-M					1,000	40106
3715-C		Socket			100	40110
3715-M					1,000	40112
3716-C		Stud			100	40116
3716-M					1,000	40118
3717-C	20	Eyelet	STEEL	SHINY BRASS	100	40122
3717-M					1,000	40124
3718-C		Cap			100	40128
3718-M					1,000	40130
3719-C		Socket			100	40134
3719-M					1,000	40136
3720-C		Stud			100	40140
3720-M					1,000	40142
4708-C	24	Eyelet	BRASS	NICKEL PLATED	100	78368
4708-M					1,000	78372
4709-C		Cap			100	78380
4709-M					1,000	78384
4710-C		Socket			100	78392
4710-M					1,000	78396
4711-C		Stud			100	78356
4711-M					1,000	78360
4713-C	24	Eyelet	BRASS	COPPER BLACK	100	78428
4713-M					1,000	78432
4714-C		Cap			100	40152
4714-M					1,000	40154
4715-C		Socket			100	40158
4715-M					1,000	40159
4716-C		Stud			100	40162
4716-M					1,000	40164
4717-C	24	Eyelet	BRASS	SHINY BRASS	100	40168
4717-M					1,000	40170
4718-C		Cap			100	40174
4718-M					1,000	40176
4719-C		Socket			100	40180
4719-M					1,000	40182
4720-C		Stud			100	40186
4720-M					1,000	40188
47221-C	24	Eyelet	STEEL	ANTIQUE	100	40268
4721-M					1,000	40270
4722-C		Cap			100	40272
4722-M					1,000	40274
4723-C		Socket			100	40276
4723-M					1,000	40278
4724-C		Stud			100	40280
4724-M					1,000	40282
4725-C	24	Eyelet	BRASS	ANTIQUE	100	50016
4725-M					1,000	50018
4726-C		Cap			100	50020
4726-M					1,000	50022
4727-C		Socket			100	50024
4727-M					1,000	50026
4728-C		Stud			100	50028
4728-M					1,000	50030
4908-C	24	Eyelet XL 3/8"	BRASS	NICKEL P.	100	40198
4908-M					1,000	40200
4909-C		Cap XL 3/8"			100	40204
4909-M					1,000	40206
5708-C	24	Eyelet	STEEL	NICKEL PLATED	100	78584
5708-M					1,000	78588
5709-C		Cap			100	78596
5709-M					1,000	75600
5710-C		Socket			100	78608
5710-M					1,000	78612
5711-C		Stud			100	78620
5711-M					1,000	78624
5713-C	24	Eyelet	STEEL	COPPER BLACK	100	40222
5713-M					1,000	40224
5714-BLK C		Cap			100	40225
5714-BLK M					1,000	40227
5714-C		Cap			100	40228
5714-M					1,000	40230
5715-C		Socket			100	40234
5715-M					1,000	40236
5716-C	Stud	100	40240			
5716-M		1,000	40242			
5717-C	24	Eyelet	STEEL	SHINY BRASS	100	40246
5717-M					1,000	40248
5718-C		Cap			100	40252
5718-M					1,000	40254
5719-C		Socket			100	40258
5719-M					1,000	40260
5720-C		Stud			100	40264
5720-M					1,000	40266
6708-C	24	Eyelet	STAINLESS STEEL	STAINLESS STEEL	100	40300
6708-M					1,000	40302
6709-C		Cap			100	40304
6709-M					1,000	40306
6710-C		Socket			100	40308
6710-M					1,000	40310
6711-C		Stud			100	40312
6711-M					1,000	40314

## SCREW STUD



Osborne No.	Description	UPC No.
4712-3/8C	Br. Screw stud 3/8" pk. 100	78404
4712-3/8M	Br. Screw stud 3/8" pk. 1000	78400
4712-5/8C	Br. Screw stud 5/8" pk. 100	78416
4712-5/8M	Br. Screw stud 5/8" pk. 1000	78420
4712SS-3/8C	SS. Screw stud 3/8" pk. 100	78410
4712SS-3/8M	SS. Screw stud 3/8" pk. 1000	78416
4712SS-5/8C	SS. Screw stud 5/8" pk. 100	78412
4712SS-5/8M	SS. Screw stud 5/8" pk. 1000	78414

Used on furniture, automobiles, recreational vehicles, manufactured housing, etc. It snaps into a nylon snap ring and shell after it's fully assembled or into a socket and cap.

<b>MATERIAL</b>	Brass	Stainless Steel
<b>FINISHES</b>	Nickel plated	Stainless Steel
<b>SIZES</b>	3/8" long and 5/8" long.	
<b>QUANTITY</b>	100 pcs per box = C or 1,000 pcs. per box = M	

**HAND VENTILATOR SETTER**



**Osborne No. 621-3/4**

**For setting 3/4" Ventilators.**

1.- Punch 9/16 hole in material (Use Osborne No. 149 -9/16" punch or on Vinyl, use No. 149 7/16 punch).

**Osborne No. 621-1**

**For setting 1" Ventilators.**

1.- Punch 3/4 hole in material(Use Osborne No. 149 -3/4" punch or on Vinyl, Use No. 149-5/8 punch).

2.- Lay ventilator neck up on base, place material over ventilator, now slip ventilator ring on bow side up. A few even taps with an Osborne Rawhide Mallet No. 196 will set ventilators.

Osborne No.	Length (inches)	Width (inches)	Weight ea. (oz)	UPC No.
<b>621 3/4</b>	4	1	14	64402
<b>621 1</b>	4	1-1/2	20	64404

**VENTILATORS**



One-piece construction for added strength. Used as breathers for mattresses, cushions and plastic slipcovers. Ventilators are solid brass. 2 sizes are available. These can be set also using Osborne Hand Press W-1 & Pneumatic Machine W-3.

**Osborne No. V-1 3/4**

Brass Plain rim ventilators used with our 621-3/4. Packed one gross.

**Osborne No. V-1 1**

Brass Plain rim ventilators used with our 621-1. Packed one gross.

Osborne No.	Diameter of hole when set (inches)	Weight/box (lbs.) (oz)	UPC No.
<b>V-1 3/4</b>	9/16	1 0	14412
<b>V-1 1</b>	3/4	1 4	14414

**VENTILATOR PUNCH**

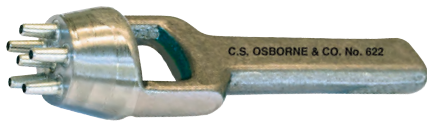

**Osborne No. 622**

Hardened and tempered steel. High quality. Used to punch ventilator holes illustrated in pattern.

Overall length (inches)	Hole diameter (inches)	Weight (oz)	UPC No.
5-1/4	3/32	10	02198

**OSBORNE E-Z CUT LEATHER SHEARS**



**Osborne No. 708**

At last a shear that cuts leather up to 8-oz. as easy as butter. Try them, compare them, you will be amazed. Knife-edge, ultra-sharp blades are chrome-plated, blunt points and ground at just the right angle for cutting leather. An Osborne exclusive.

Overall length (inches)	Length of cut (inches)	Point style	Weight (oz)	UPC No.
8-1/4	3	Blunt	7	60692

**8" BENT TRIMMER SHEARS**



**Osborne No. 164**

Hot drop-forged and fully nickel plated with black enamel handles for durable, long-term value.

Overall length (inches)	Length of cut (inches)	Point style	Weight (oz)	UPC No.
8-1/2	3-1/2	Sharp	7	60570



## WISS BENT TRIMMER SHEARS



### Osborne No. W20 & W22N

Commonly used in cutting fabrics, upholstery, & composite materials. Precision ground blades for sharper cutting edges & longer blade life. Handle rings designed to comfortably fit users hands. SET-EASY pivot adjustment easily & securely adjust to users preference. Hot dropped forged nickel plated blades.

Osborne No.	Overall length (inches)	Length of cut (inches)	Point Style	Weight (oz)	UPC No.
W20	10 <sup>3</sup> / <sub>8</sub>	4 <sup>3</sup> / <sub>4</sub>	Sharp	12	60512
W22N	12 <sup>1</sup> / <sub>2</sub>	6	Sharp	18	60532

## WISS BENT TRIMMER SHEARS



### Osborne No. W20P

Similar to above shear but with red cushion grip handles that give maximum comfort. Handle rings designed to comfortably fit user hands.

Osborne No.	Overall length (inches)	Length of cut (inches)	Point Style	Weight (oz)	UPC No.
W20P	10 <sup>3</sup> / <sub>8</sub>	4 <sup>3</sup> / <sub>4</sub>	Sharp	12	60516

## WISS BENT TRIMMER SHEARS



### Osborne No. W20LH

Similar to our above Osborne No. W20 but for **left handed user**.

Osborne No.	Overall length (inches)	Length of cut (inches)	Point Style	Weight (oz)	UPC No.
W20LH	10 <sup>3</sup> / <sub>8</sub>	4 <sup>3</sup> / <sub>4</sub>	Sharp	12	60520

## WISS UPHOLSTERY & CARPET SHEARS



### Osborne No. W20W & W22W

Thick, heavy duty blades for cutting multiple layers & tough materials. Precision ground blades for sharper cutting edges & longer blade life. Handle rings designed to comfortably fit users hands. SET-EASY pivot adjustment easily & securely adjust to users preference. Hot dropped forged nickel plated blades.

Osborne No.	Overall length (inches)	Length of cut (inches)	Point Style	Weight (oz)	UPC No.
W20W	10	4 <sup>7</sup> / <sub>8</sub>	Sharp	14	60524
W22W	12	6 <sup>1</sup> / <sub>8</sub>	Sharp	20	60536

## WISS BENT TRIMMER SHEARS



### Osborne No. 27N, 28N & 29N

Professional dressmaker and industrial use. Finest quality cutlery steel. Hot drop-forged nickel-plated blades. Patented SET-EASY® pivot.

Osborne No.	Overall length (inches)	Length of cut (inches)	Point Style	Weight (oz)	UPC No.
27N	7	2 <sup>3</sup> / <sub>4</sub>	Sharp	4	60552
28N	8	3 <sup>3</sup> / <sub>8</sub>	Sharp	6	60562
29N	9	4	Sharp	8	60582



## WISS BENT TRIMMER SHEARS

Knife Edge



### Osborne No. W1225 & W1226

Ideal for cutting carpet, synthetic fibers & composite materials. One blade ground to knife edge for faster, cleaner cutting. Precision ground blades for sharper cutting edges & longer blade life. Handle rings designed to comfortably fit users hands. SET-EASY pivot adjustment easily and securely adjust to users preference. Hot dropped forged nickel plated blades.

Osborne No.	Overall length (inches)	Length of cut (inches)	Point Style	Weight (oz)	UPC No.
W1225	10 <sup>3</sup> / <sub>8</sub>	5	Sharp	14	60542
W1226	12 <sup>1</sup> / <sub>2</sub>	6	Sharp	20	60544

## WISS STRAIGHT TRIMMER SHEARS



### Osborne No. 38N & W30

For cutting various fabrics & upholstery. Precision ground blades for sharper cutting edges & longer blade life. Handle rings designed to comfortably fit users hands. SET-EASY pivot adjustment easily & securely adjust to users preference. Hot dropped forged nickel plated blades.

Osborne No.	Overall length (inches)	Length of cut (inches)	Point Style	Weight (oz)	UPC No.
38N	8 <sup>1</sup> / <sub>4</sub>	3 <sup>5</sup> / <sub>8</sub>	Sharp	5	60612
W30	10 <sup>3</sup> / <sub>8</sub>	5	Sharp	12	60592

## WISS AUTO BODY SHEARS



### Osborne No. 1DSN

Made from carbon steel. Nickel-plated blades and handle. Hot drop-forged commercial. Adjustable nut.

Osborne No.	Overall length (inches)	Length of cut (inches)	Point Style	Weight (oz)	UPC No.
1DSN	8 <sup>1</sup> / <sub>8</sub>	2 <sup>3</sup> / <sub>4</sub>	Sharp	7	60712

## WISS RUG SHEARS



### Osborne No. RS1N

Hot drop-forged solid steel. Offset black handle. Nickel-plated blades with sharp points.

Osborne No.	Overall length (inches)	Length of cut (inches)	Point Style	Weight (oz)	UPC No.
RS1N	8	2 <sup>7</sup> / <sub>8</sub>	Sharp	6	60722

## WISS AUTO DUTY UTILITY SHEARS



### Osborne No. 2DAN

Cuts wire used in floral designs and other similar crafts. Hot drop forged commercial nickel plated solid steel. Serrated nickel-plated blades grips cutting material. Black, curved handle designed for comfort and fatigue reduction.

Osborne No.	Overall length (inches)	Length of cut (inches)	Point Style	Weight (oz)	UPC No.
2DAN	7 <sup>3</sup> / <sub>4</sub>	2	Sharp	9	60762

## WISS QUICK-CLIP SPEED CUTTERS



### Osborne No. 1570B

Stainless steel blades. Positive spring action opens blades for fast cutting. Heavy duty contour designed frames. Ideal for thread cutting, seam ripping, garment finishing, flower spring, etc. Sharp points. Industrial PVC plastic handle. Replacement blades also available Osborne No. 1570-K.

Osborne No.	Overall length (inches)	Length of cut (inches)	Point Style	Weight (oz)	UPC No.
1570B	4 <sup>3</sup> / <sub>4</sub>	1	Sharp	2	10782



## KAI SHEARS - Stainless Steel



THE BEST SHEAR YOU'LL EVER USE

### Osborne No. K7250, K7280 & K7300

High carbon molybdenum. Vanadium Stainless Steel Blades. Exceptionally sharp, long lasting edge life for total cutting efficiency. Interlocking screw design optimizes superior blade tension. Perfectly balanced, light weight construction with soft ergonomic grips.

Osborne No.	Overall length (inches)	Length of cut (inches)	Weight (oz)	UPC No.
K7250	10	3 3/4	10	15602
K7280	11	4 3/4	11	15604
K7300	12	5 1/2	12	15606

3 sizes available

## WISS THREAD CLIPS



### Osborne No. TC1

Ideal for cutting threads, strings and ripping seams. Positive action, self opening spring provides fast, clean cutting. Hot drop-forged of fine cutlery steel. Regular edge. Sharp points. Nickel plated.

Osborne No.	Overall length (inches)	Length of cut (inches)	Point Style	Weight (oz)	UPC No.
TC1	4 3/4	1 1/8	Sharp	2	60772

## WISS THREAD CLIPS



### Osborne No. TC5

Quality hot drop-forged cutlery steel. Self-opening spring-action assures fast, effortless cutting. Fully nickel-plated. Blunt points.

Osborne No.	Overall length (inches)	Length of cut (inches)	Point Style	Weight (oz)	UPC No.
TC5	4 5/8	1	Blunt	2	60776

## WISS LEATHER & BELT CUTTING SHEARS



### Osborne No. W8BLT

Specially designed for cutting heavy leather or tough materials. One blade serrated to prevent slipping. Heavy construction, power leverage. Straight handles, enameled black. Polished blades.

Osborne No.	Overall length (inches)	Length of cut (inches)	Point Style	Weight (oz)	UPC No.
WBLT	8 1/2	3 3/8	Blunt	2	60708

## WISS EMBROIDERY SCISSORS



### Osborne No. 764

Specially designed for intricate cutting, embroidery and fine needlework. Hot drop-forged and nickel-plated. Ring handle. Double sharp points. Flat pattern. Attractive vinyl package.

Osborne No.	Overall length (inches)	Length of cut (inches)	Point Style	Weight (oz)	UPC No.
764	4 1/8	1 1/4	Sharp	2	58116

## WISS STRAIGHT BLADES METAL SNIPS



### Osborne No. J-7s

Used in electronic and appliance light metal cutting. Comes with polished straight blades. Black handles.

Osborne No.	Overall length (inches)	Length of cut (inches)	Weight (oz)	UPC No.
J-7S	7	1	2	52116



## 10" MUNDIAL BENT TRIMMER SHEARS



### Osborne No. 498-10

Hot drop-forged and fully nickel plated with black enamel handles. Knife Edge. Stay-Set Pivot. Packed in a nice display box with picture of the shears printed on the outside.

Osborne No.	Overall length (inches)	Length of cut (inches)	Point Style	Weight (oz)	UPC No.
498-10	10	4 <sup>7</sup> / <sub>8</sub>	Sharp	14	60514

## 12" MUNDIAL BENT TRIMMER SHEARS



### Osborne No. 498-12

Hot drop-forged and fully nickel plated with black enamel handles. Knife Edge. Stay-Set Pivot. Packed in a nice display box with picture of the shears printed on the outside.

Osborne No.	Overall length (inches)	Length of cut (inches)	Point Style	Weight (oz)	UPC No.
498-12	12	6 <sup>1</sup> / <sub>8</sub>	Sharp	18	60534

## 10" MUNDIAL TRUE LEFT HAND BENT TRIMMER SHEARS



### Osborne No. 493-10

Hot drop-forged and fully nickel plated with black enamel handles. Knife Edge. Stay-Set Pivot. Packed in a nice display box with picture of the shears printed on the outside.

Osborne No.	Overall length (inches)	Length of cut (inches)	Point Style	Weight (oz)	UPC No.
498-10	10	4 <sup>7</sup> / <sub>8</sub>	Sharp	14	68538

## 8-1/2" MUNDIAL DRESSMAKER SHEARS



### Osborne No. 1860-1

Enlarged finger bows and soft-touch inserts for comfortable non-slip grip. Micro-serrated bottom blade provides maximum control in cutting even the most delicate, silky fabrics. Navy/Powder Blue cushion soft. Packed in a hang up display card.

Osborne No.	Overall length (inches)	Length of cut (inches)	Point Style	Weight (oz)	UPC No.
1860-1	8 <sup>1</sup> / <sub>2</sub>	3 <sup>5</sup> / <sub>8</sub>	Sharp	6	10536

## 9-1/2" MUNDIAL PROF. DRESSMAKER SHEARS



### Osborne No. 1890-1

Enlarged finger bows and soft-touch inserts for comfortable non-slip grip. Micro-serrated bottom blade provides maximum control in cutting even the most delicate, silky fabrics. Navy/Powder Blue cushion soft. Packed in a hang up display card.

Osborne No.	Overall length (inches)	Length of cut (inches)	Point Style	Weight (oz)	UPC No.
1890-1	9 <sup>1</sup> / <sub>2</sub>	4 <sup>1</sup> / <sub>8</sub>	Sharp	8	15618

## 7" MUNDIAL BENT TRIMMER SHEARS



### Osborne No. 270-7

Hot drop-forged and fully nickel plated with black enamel handles for durable, long-term value.

Osborne No.	Overall length (inches)	Length of cut (inches)	Point Style	Weight (oz)	UPC No.
270-7	7	5	Sharp	6	60554

## 8" MUNDIAL BENT TRIMMER SHEARS



### Osborne No. 270-8

Similar to above but 8" long. Hot drop-forged and fully nickel plated with black enamel handles for durable, long-term value.

Osborne No.	Overall length (inches)	Length of cut (inches)	Point Style	Weight (oz)	UPC No.
270-8	8	3 <sup>5</sup> / <sub>8</sub>	Sharp	7	60564



## HOG RING PLIER WITH VINYL HANDLES Osborne No. 1440

9 different styles with straight or angled handles, come with opening spring, closing spring and no spring. Please specify style. Grooves are the proper depth. Made of **forged** steel. Use with Osborne hog rings.

EACH PLIER IS PACKED ON A DISPLAY CARDBOARD 11" x 4".

Osborne No.	Spring Type	Description	UPC No.
1440-A	NO SPRING	Straight handle.	54132
1440-B		Upward 135 degree bent handle.	54138
1440-C		Side bent handle.	54144

1440-AO	OPENING SPRING	Straight handle.	54134
1440-BO		Upward 135 degree bent handle.	54140
1440-CO		Side bent handle.	54146

1440-AC	CLOSING SPRING	Straight handle.	54136
1440-BC		Upward 135 degree bent handle.	54142
1440-CC		Side bent handle.	54148

All handles and jaws are aligned. 6-3/4" overall length. Weight each 8 oz.

### REPLACEMENT PARTS

Osborne No.	Description	UPC No.
1440-SO	Replacement opening spring only	54152
1440-SC	Replacement closing spring only	54154

### OPENING SPRING



### NO SPRING



### CLOSING SPRING





## HOG RING PLIER WITH VINYL BOW HANDLES

9 different styles with opening spring, closing spring and no spring. Similar to 1440's but with **BOW** handles joined by a RIVET or a BOLT with NUT & WASHER. Please specify style. Grooves are the proper depth. Made of **forged** steel. Use with Osborne hog rings.

Osborne No.	Handle Type	Description	UPC No.
23-M	STRAIGHT	No spring	54182
23P-M		Closing spring	54184
23S-M		Open spring	54186

23T-M	STRAIGHT	No spring	54188
23TP-M		Closing spring	54190
23TS-M		Open spring	54192

2360T-M	BENT	No spring	54206
2360TP-M		Closing spring	54207
2360TS-M		Open spring	54208

6-3/4" overall length. Weight each 9 oz.

### REPLACEMENT PARTS

Osborne No.	Description	UPC No.
1440-SO	Replacement opening spring only	54152
1440-SC	Replacement closing spring only	54154

Joint held by rivet. Handles have been redesigned to fit the palm of the hand.



Tension type hog ring pliers. The joint is held by a bolt, nut and tension washer; this keeps the joint from freezing and helps hold the hog ring when pliers are laid down.



The joint is held by a bolt, nut and tension washer; this keeps the joint from freezing and helps hold the hog ring when pliers are laid down. These 3 styles have upward 135 degree bent handle.





## HOG RINGS - SHARP POINTS

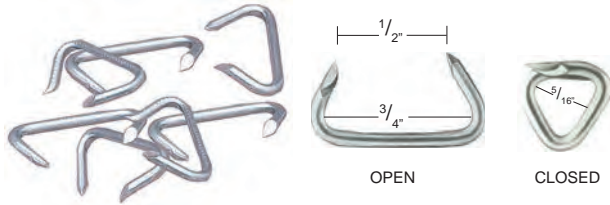

### Osborne No. 1442

Bright finish, low carbon steel, not galvanized, polished. 14 wire gauge. Size  $\frac{3}{4}$ " . Packed and sold in 5 or 25 lbs. strong cartons. To be used with our No. 1440 & No. 773-HRP Hog Rings Pliers.

Osborne No.	Package (lbs.)	Approximate rings per box	UPC No.
<b>1442-5</b>	5 lbs. box	2,000	14592
<b>1442-25</b>	25 lbs. box	10,000	14594

### Osborne No. 1444SS-5

Same specs as Osborne No. 1442 but **Stainless Steel**. Packed and sold in 5 lbs. strong carton. UPC No. 14600.

## HOG RINGS - BLUNT POINTS

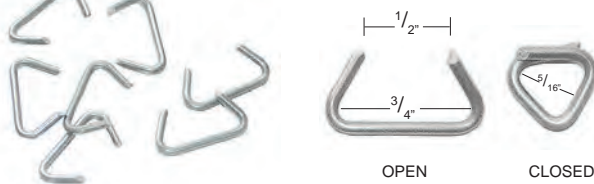

### Osborne No. 1443

Bright finish, low carbon steel, not galvanized. 14 wire gauge. Polished 2" overall. Packed and sold in 5 or 25 lbs. strong carton. To be used with our No. 1440 & No. 773-HRP Hog Rings Pliers.

Osborne No.	Package (lbs.)	Approximate rings per box	UPC No.
<b>1443-5</b>	5 lbs. box	2,000	14596
<b>1443-25</b>	25 lbs. box	10,000	14598

## HOG RINGS - COPPER COATED

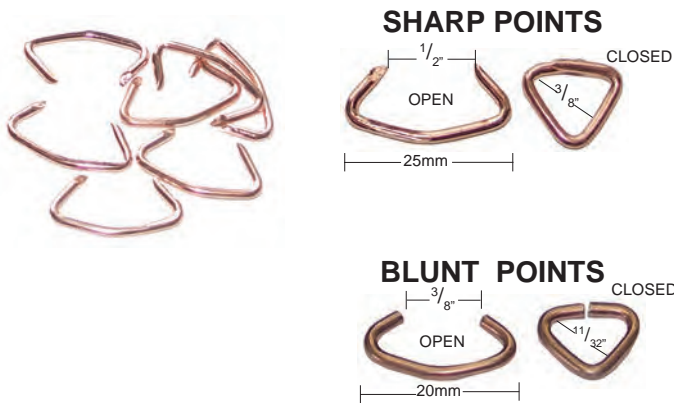

### Osborne No. 773

Copper coated hog rings. 14 wire gauge. Available with sharp points or with blunt points. Packed and sold in boxes of 1,000 pcs. To be used with our Osborne No. 773-HRP Hog Ring Pliers. They can also be set with our Osborne series No. 1440 as well.

Osborne No.	Description	Distance between points	Overall length	UPC No.
<b>773-K 25</b>	25mm Sharp pt. rings	1/2"	2"	64799
<b>773-KB 20</b>	20mm Blunt pt. rings	3/8"	1-3/4"	64801
<b>773-KS 20</b>	25mm Sharp pt. rings	3/8"	1-3/4"	64797

## HOG RING PLIER



### Osborne No. 773-HRP

Hardened and tempered. **Forged** steel. Vinyl handles. Closing spring loaded. Works with hog rings series 773. It can also close hog rings series 1442 & 1443 & 1444. Ideal for closing around small areas.

Length (inches)	Weight each (oz.)	UPC No.
7 $\frac{1}{8}$	8	64794

## PINCERS, FLUSH CUT



FLUSH CUT

### Osborne No. 93

A rugged forged steel pincer for heavy cutting. Polished flush cut jaws for getting close to a flat surface.

Length (inches)	Weight ea (oz)	UPC No.
8	13	54112

## END CUTTING NIPPER



BEVEL CUT

### Osborne No. 94

An excellent small nipper. Made of drop forged steel. Black finish, polished jaws. Bevel cut. Vinyl grips to add comfort.

Length (inches)	Weight ea (oz)	UPC No.
6-3/8	7	54122

## DIAGONAL CUTTING NIPPERS

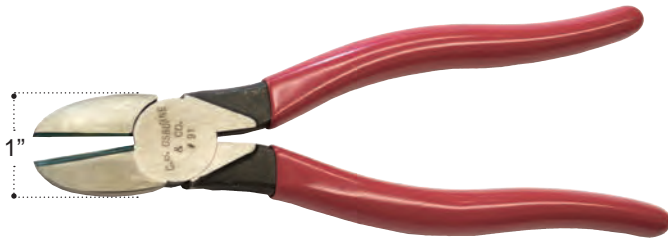

1"

### Osborne No. 91

These rugged drop forged nippers are ideal for cutting hog rings and wire. Polished head, finest industrial quality. Bevel cut. Red vinyl grips to add comfort.

Length (inches)	Jaw thickness (inches)	Weight ea. (oz)	UPC No.
8	9/16	13	54082

## DIAGONAL CUTTING NIPPERS



7/8"

### Osborne No. 3377

Similar to above but shorter and lighter. These rugged drop forged nippers are ideal for cutting hog rings and wire. Polished head, finest industrial quality. Red vinyl grips to add comfort. Bevel cut.

Length (inches)	Jaw thickness (inches)	Weight ea (oz)	UPC No.
7-1/4	7/16	7	54072

**VINYL ROOF, CARPET AND VENEER ROLLER**

**Osborne No. 399**

Roll it on vinyl roofs, gets all the air pockets out and on interior carpeting to smooth it out. This tool can also be used for Veneer work in furniture. Available in 2 sizes. Round edge, single side design to get close to walls. Ball bearing race. Available in two handle sizes.



Osborne No.	Overall length (inches)	Weight each (lbs.)	UPC No.
<b>399-S</b>	9 1/2	2 1/4	14304
<b>399-L</b>	12	2 1/2	14302

**TUCKING TOOL - RIGID**

**Osborne No. 747**

For tucking headlining and upholstery around windows and above doors and other hard to reach places. A sturdy tough tool with a slightly curved steel blade that has finished edges and rounded corners. Comfortable hardwood riveted handle.



Osborne No.	Blade length (inches)	Overall length (inches)	Weight (oz)	UPC No.
747	2-5/8	7-1/2	4	64704

**TUCKING TOOL - FLEXIBLE**

**Osborne No. 746**

Same as above but with flexible spring steel blade. A very popular tool. Hardwood riveted handle.



Osborne No.	Blade length (inches)	Overall length (inches)	Weight (oz)	UPC No.
746	2-5/8	7-1/2	4	64702

**TUCKING TOOL - PLASTIC BLADE**

**Osborne No. 745**

Same as above but with flexible plastic blade. Hardwood riveted handle

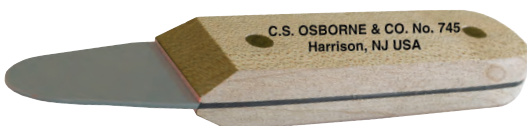

Osborne No.	Blade length (inches)	Overall length (inches)	Weight (oz)	UPC No.
745	2	6-3/4	3	64700

## HEADREST RELEASE KEY SET



### Osborne No. K-752

Set of 4 Headrest Release Keys No. 752's. Removes the headrest from most american cars. Instructions included.

1 each of the following sizes				Weight / set (oz)	UPC No.
Size (inches)	1/4	5/16	1/2		
			3/4	6	14722

## DOOR HANDLE CLIP REMOVER



### Osborne No. 758

High quality. Perfect for auto trim work. Plated. An industry standard.

Overall length (inches)	Weight ea. (oz)	UPC No.
7	4	64764

## MOULDING RELEASE KEY



### Osborne No. 757

High quality. Perfect for auto trim work. Plated.

Overall length (inches)	Weight ea. (oz)	UPC No.
7	4	64762

## TRIM PAD REMOVER



### Osborne No. 760

High quality. Perfect for auto trim work. Plated.

Overall length (inches)	Weight ea. (oz)	UPC No.
8-1/2	4	64766

## RETAINER CLIP INSTALLER

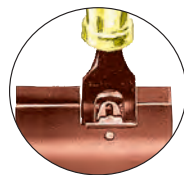

### Osborne No. 99

A practical tool for placing trim retainer clips over headed studs welded around the body window shields and rear window openings. This tool reduces the risk of chips and scratches to glass windows put in by make-shift tools. This tool is specifically designed to fit trim clips over the studs and virtually eliminates glass breakage. It also dispenses with the need to remove rubber-like sealant surroundings the studs.

Overall length (inches)	Weight ea. (oz)	UPC No.
7	5	64166

## MOULDING CLIP TOOL



### Osborne No. 97

This clever tool installs and removes the plastic clips which hold moulding strips. Just press down and slide clip on or off. Helps avoid scratches on new finishes or injury to worker's hand. A useful tool designed to save time and money. It makes this job so easy.

Overall length (inches)	Weight ea. (oz)	UPC No.
7	4	64163

## THE SKIFE



NICKEL PLATED

### Osborne No. 925

Makes a remarkably easy job of skiving vinyl and other materials. Increases both speed and accuracy. This essential tool is fitted with a special stainless steel razor blade. Ideal for restoration work. Extra blades available.

### Osborne No. 925-D

Safety dispenser with 20 STAINLESS STEEL BLADES.

### Osborne No. 925-100

Bulk pack of 100 STAINLESS STEEL blades.

Osborne No.	Description	Weight ea. (oz)	UPC No.
925	Skife knife	2	60182
925-D	Dispenser	3	04113
925-100	100 blades	4	10183

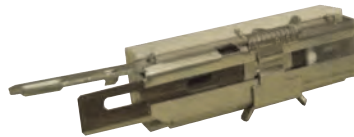

No. 925-D



No. 925-100

## SEAM RIPPER



C.S. OSBORNE & CO. No. 1020

### Osborne No. 1020

Made of finest steel with both hook and pointed blade. Used for ripping seams. Cuts auto carpeting, vinyl, plastic and rubber. Beechwood handle contoured to fit hand. A handy professional tool.

Length of blade (inches)	Weight ea. (oz)	UPC No.
2-7/8	4	60146

## SHARPENING STONE



C.S. OSBORNE & CO. No. 1021

### Osborne No. 1021

Specially contoured stone to sharpen the hook as well as the other parts of the Osborne No. 1020 knife. This quality stone can be used to sharpen other Osborne knives.

Overall length (inches)	Diameter (inches)	Weight ea. (oz)	UPC No.
6	3/4	2	64512

## HAWKBILL KNIFE



C.S. OSBORNE & CO. No. 420

### Osborne No. 420

This hawkbill knife is made of finest cutlery steel. Varnished hardwood handle.

Length of blade (inches)	Weight ea. (oz)	UPC No.
3	2	60100



## SQUARE POINT KNIFE



### Osborne No. 76

The finest quality knife with lacquered round plantation hardwood handle, easy to hold, brass ferrule. Widely used in many industries. Steel blade.

Length of blade (inches)	Width of blade (inches)	Weight ea (oz)	UPC No.
3 3/4	3/4	2	60042

## SQUARE POINT KNIVES



C. S. OSBORNE No. 76 1/2



C. S. OSBORNE No. 77

### Osborne No. 76 1/2 & 77

Trimmer's and upholsterer's knife. Lacquered hardwood handle is somewhat shorter and heavier than in the Osborne No. 76. Steel blade. Also available with steel safety guard **Osborne No. 77** UPC No. 60050.

Length of blade (inches)	Width of blade (inches)	Weight ea. (oz)	76 1/2 UPC No.	77 UPC No.
3 7/8	5/8	2	60046	60050

## BROAD POINT KNIVES



C.S.OSBORNE & CO. No. 78



C.S.OSBORNE & CO. No. 78 1/2

### Osborne No. 78 & 78 1/2

Round lacquered hardwood handle. Steel blade. Also available with safety guard **Osborne No. 78 1/2**.

Length of blade (inches)	Width of blade (inches)	Weight ea. (oz)	78 UPC No.	78 1/2 UPC No.
5	1 1/8	2	60054	60058

## SHARP POINT KNIFE



C.S.OSBORNE & CO. No. 79 1/2

### Osborne No. 79 1/2

Lacquered hardwood handle, sharp point knife. A popular knife in the upholstery and trimming industry. Steel blade.

Length of blade (inches)	Width of blade (inches)	Weight ea (oz)	UPC No.
3 3/4	3/4	2	60060

## BEVEL POINT KNIFE



C.S. OSBORNE & CO. No. 479

### Osborne No. 479

Used for skiving and edge trimming on leather and similar materials. Plated ferrule. Lacquered hardwood handle.

Length of blade (inches)	Weight ea (oz)	UPC No.
3	2	60112

## SAFETY SHEATH FOR OSBORNE KNIVES



### Osborne No. 72

A sturdy leather sheath for our industrial knives. Slits fit on belt. Stitched edges reinforced with seven rivets.

Overall length (inches)	Length of pocket (inches)	Width (inches)	Weight ea. (oz)	UPC No.
10	5 1/4	2	3	60184



## DEAD BLOW HAMMER



### Osborne No. 391

Minimizes damage to the struck surface and controls force with minimal rebound. Head is filled with shot, which absorbs the impact of a strike, reducing the bounce-back. Used in many applications. Available in 4 sizes.

Osborne No.	Description	Weight ea. (lbs.)	UPC No.
391 1	Dead blow hammer 1 lb.	1	11066
391 1-1/2	Dead blow hammer 1-1/2 lb.	1-1/2	11068
391 2	Dead blow hammer 2 lb.	2	11070
391 3	Dead blow hammer 3 lb.	3	11072

## SPLIT HEAD HAMMER

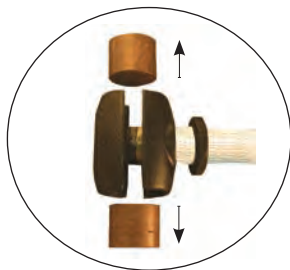

### Osborne No. 395

Ideal for use with punches, grommet dies and wherever a cushioned blow is desired. No trouble to replace faces. Just loosen the safety nut, remove the worn face, insert replacement and tighten. Long wearing. Rawhide, nylon, urethane and copper faces available. Rawhide faces supplied if none are specified.

Osborne No.	Description	Weight pair (lbs) (oz)	Diameter of face (inches)	Length of head (inches)	UPC No.
395-1R	Sz. 1 - Rawhide	1 9	1 1/4	3 5/8	11090
395-2R	Sz. 2 - Rawhide	2 -	1 1/2	4 1/4	11094
395-3R	Sz. 3 - Rawhide	2 15	1 3/4	4 7/8	11098
395-1N	Sz. 1 - Nylon	1 8	1 1/4	3 5/8	11092
395-2N	Sz. 2 - Nylon	2 -	1 1/2	4 1/4	11096
395-3N	Sz. 3 - Nylon	2 15	1 3/4	4 7/8	11100
395-1U	Sz. 1 - Urethane	1 8	1 1/4	3 5/8	11091
395-2U	Sz. 2 - Urethane	2 -	1 1/2	4 1/4	11095
395-3U	Sz. 3 - Urethane	2 15	1 3/4	4 7/8	11099
395-1C	Sz. 1 - Copper	2 -	1 1/4	3 5/8	11093
395-2C	Sz. 2 - Copper	2 15	1 1/2	4 1/4	11097
395-3C	Sz. 3 - Copper	4 4	1 3/4	4 7/8	11101

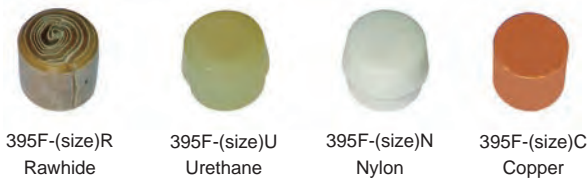

#### REPLACEMENT FACES

RAWHIDE		NYLON		URETHANE		COPPER	
Osborne No.	UPC No.	Osborne No.	UPC No.	Osborne No.	UPC No.	Osborne No.	UPC No.
395F-1R	11103	395F-1N	11105	395F-1U	11104	395F-1C	11106
395F-2R	11107	395F-2N	11109	395F-2U	11108	395F-2C	11110
395F-3R	11111	395F-3N	11113	395F-3U	11112	395F-3C	11114

## RAWHIDE MALLET - With solid head



### Osborne No. 196

Light-weight mallet head made of rolled water buffalo rawhide. White hickory handle. Recommended for many jobs where a soft striking face is required.

Size No.	Length of head (inches)	Diameter of face (inches)	Length of handle(in)	Weight each (oz)	UPC No.
0	2 3/8	1	9	2	11052
1	3 1/8	1 1/4	9	4	11054
2	3 1/4	1 1/2	9 1/4	6	11056
3	3 3/8	1 3/4	10 1/4	8	11058
4	3 1/2	2	10 1/4	10	11060
5	4	2 1/2	11 1/4	16	11062
6	4 1/2	2 3/4	11 1/4	20	11064



## POLY Mallet



### Osborne No. 496

The strong polymer head is wear resistant and long lasting. The special material absorbs shock and minimizes the mallet bouncing back. Hardwood handle.

Length of head (inches)	Diameter of face (inches)	Length of handle (inches)	Weight ea. (oz)	UPC No.
3 1/2	1 3/4	10	8	11082

## Barrel Shaped Hickory Mallet



### Osborne No. 89.5

Made of hardwood hickory, a carefully finished, well balanced, heavy mallet. Lacquered.

Size No.	Diameter of face (inches)	Length of head (inches)	Length of handle (inches)	Weight ea. (oz)	UPC No.
2	2 1/2	6	11 1/2	24	61012
2 1/2	2 3/8	5 1/2	10 1/2	15	61014
3	2 1/4	5 1/2	10 1/4	12	61016
3 1/2	2	5 1/4	10 1/4	12	61018
4	1 3/4	5	10 1/4	8	61020

## Hickory Mallet



### Osborne No. 90

A serviceable and sturdy mallet. Made of hardwood hickory. Lacquered.

Size No.	Diameter of face (inches)	Length of head (inches)	Length of handle (inches)	Weight ea. (oz)	UPC No.
2	2 3/4	5 1/2	10 1/2	18	61032
3	2 1/2	5 1/2	10 1/2	17	61034
4	2	5	10 1/2	14	61036
5	2	4	9	8	61038

## Black Rubber Mallet



### Osborne No. 197

Rubber mallets can be used without fear of marring. Limited bounce. Head of solid dense black rubber with hardwood handle. Finest quality of rubber. Duro hardness is 70 with 5% tolerance. 2 sizes are available.

Size No.	Diameter of face (inches)	Length of head (inches)	Overall length (inches)	Weight ea (oz)	UPC No.
2	2	3 1/4	12	11	61162
3	2 1/2	4 1/2	14	24	61164

## White Rubber Mallet



### Osborne No. 396

Extra heavy white rubber mallet will not mar or mark surface. Superior quality of rubber. Limited bounce. Hardwood handle. Duro hardness is 70 with 5% tolerance. Available in 2 sizes. Replacement handles are also sold separately.

Size No.	Diameter of face (inches)	Length of head (inches)	Overall length (inches)	Weight ea (oz)	UPC No.
2	2	3 1/4	12	13	61142
3	2 1/2	4 1/2	14	28	61146



## RAWHIDE MAULS

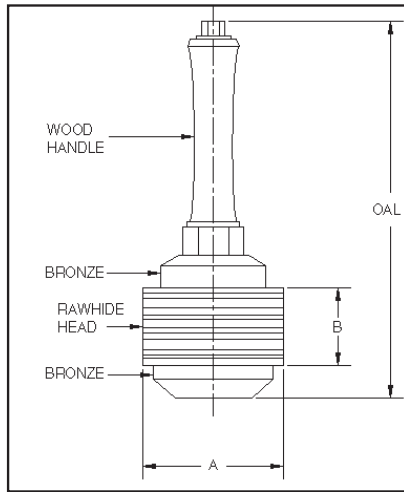

### Osborne No. 393

Well balanced and built to last. The water buffalo hides are uniquely treated for maximum durability and shock absorbance. Easy to handle, they strike square and deliver controlled dead blows. Used with tarp, tent, awning, canvas, sail making, tool & die shops, leather crafting, cutting dies, etc. The laminated heads are specially compressed between 2 brass flanges, connected to a lacquered oak handle by an internal solid steel rod.

**RAWHIDE REFILLS** also available.

Replacement parts sold separately.

Osborne No.	Approximate Weight	Head Diameter "A"	Head Length "B"	Overall Length "OAL"	UPC No.
<b>393-1-1/2</b>	1-1/2 lbs.	2-1/2"	1-5/16"	8-1/4"	11008
<b>393-2</b>	2 lbs.	2-3/4"	1-5/8"	8-3/4"	11020
<b>393-3</b>	3 lbs.	3"	1-3/4"	9-1/4"	11022
<b>393-4</b>	4 lbs.	3-5/8"	2-1/4"	10"	11024
<b>393-6</b>	6 lbs.	4"	2-1/4"	10-3/4"	11026
<b>393-8</b>	8 lbs.	4-1/4"	2-1/4"	11"	11028

Replacement parts are also available.

## NYLON MAULS

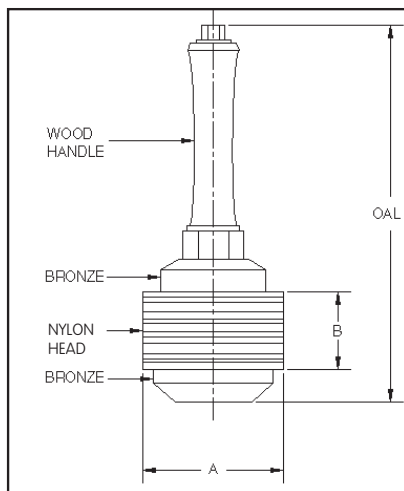

### Osborne No. 392

Similar in construction and specs to above rawhide mauls but fitted with nylon head.

**NYLON REFILLS** also available.

Replacement parts sold separately.

Osborne No.	Approximate Weight	Head Diameter "A"	Head Length "B"	Overall Length "OAL"	UPC No.
<b>392-1-1/2</b>	1-1/2 lbs.	2-1/2"	1-5/16"	8-1/4"	11000
<b>392-2</b>	2 lbs.	2-3/4"	1-5/8"	8-3/4"	11001
<b>392-3</b>	3 lbs.	3"	1-3/4"	9-1/4"	11002
<b>392-4</b>	4 lbs.	3-5/8"	2-1/4"	10"	11003
<b>392-6</b>	6 lbs.	4"	2-1/4"	10-3/4"	11004
<b>392-8</b>	8 lbs.	4-1/4"	2-1/4"	11"	11005



The punches below are forge from the finest quality high carbon steel. Hardened and tempered points for industrial use. Pointed ends are highly polished. Hexagon shanks with industrial finish.

## CENTER PUNCHES

### Osborne No. 353



Hex stock size(inches)	Length (inches)	Weight ea. (oz)	UPC No.
1/4	6	1	52310
3/8	5	2	52312
1/2	6	5	52314
5/8	6 1/2	8	52316

## PRICK PUNCHES

### Osborne No. 354



Hex stock size(inches)	Length (inches)	Weight ea. (oz)	UPC No.
1/4	4 1/2	1	52330
5/16	4 1/2	2	52332
3/8	5	5	52334
1/2	6	8	52336
5/8	6 1/4	8	52338

## SOLID PUNCHES

### Osborne No. 355



Point diameter (inches)	Hex stock size(inches)	Length (inches)	Weight ea. (oz)	UPC No.
1/8	3/8	4 1/2	2	52400
1/4	1/2	6	8	52404
3/16	3/8	5	2	52402
5/16	21/32	9	12	52406
3/8	3/4	6 1/2	19	52408

## PIN PUNCHES

### Osborne No. 357



Point diameter (inches)	Hex stock size(inches)	Length (inches)	Weight ea. (oz)	UPC No.
3/32	5/16	4 1/2	1	52370
1/8	5/16	6	2	52372
5/32	5/16	6	2	52374
3/16 x 3/8	3/8	5 1/2	2	52376
7/32	3/8	6	2	52380
3/16 x 1/2	1/2	6	4	52378
1/4	1/2	6	4	52382
5/16	1/2	9	6	52384

## ALIGNING PUNCHES

### Osborne No. 359



Point diameter (inches)	Hex stock size(inches)	Length (inches)	Weight ea. (lbs.)	Weight ea. (oz.)	UPC No.
1/4	5/8	10	-	8	52350
5/16	5/8	12	-	15	52356
5/16	3/4	12	1	4	52354
3/8	3/4	15	2	1	52352



These punches should be used on an Osborne No. #603 Cutting pad.  
The use of an Osborne wooden mallet or rawhide hammer is recommended.  
Steel hammers are not recommended.

**ARCH PUNCH** - Original and correct design for cutting

### Osborne No. 149

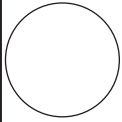

Meets Government Standards

Osborne arch punches are drop forged in one piece from the finest special carbon steel in sizes from 1/8" to 2-1/8" diameter. Larger sizes are made with our properly engineered two piece welded construction. A unique feature of the Osborne arch punch is the inside taper which permits the punchings to clear easily through the barrel. Punches have fully polished barrel. The cutting edge is fully hardened all the way through and properly finished to provide long use trouble free punching.

**INCHES** stock sizes shown below:

Diameter (inches)	Weight ea (lbs) (oz)	UPC No.	Diameter (inches)	Weight ea (lbs) (oz)	UPC No.	Diameter (inches)	Weight ea (lbs) (oz)	UPC No.	Diameter (inches)	Weight ea (lbs) (oz)	UPC No.	Diameter (inches)	Weight ea (lbs) (oz)	UPC No.
1/8	- 2	01008	1 1/2	2 -	01052	2 7/8	2 13	01096	4 1/4	5 -	01140	5 5/8	5 14	01172
3/16	- 2	01010	1 9/16	1 14	01054	2 15/16	2 11	01098	4 5/16	5 -	01142	5 11/16	5 14	01173
1/4	- 2	01012	1 5/8	1 14	01056	3	2 12	01100	4 3/8	5 1	01144	5 3/4	5 14	01174
5/16	- 2	01014	1 11/16	1 8	01058	3 1/16	2 5	01102	4 7/16	5 1	01146	5 13/16	5 15	01175
3/8	- 3	01016	1 3/4	2 6	01060	3 1/8	2 9	01104	4 1/2	5 1	01148	5 7/8	5 15	01176
7/16	- 5	01018	1 13/16	2 5	01062	3 3/16	2 13	01106	4 9/16	5 2	01150	5 15/16	6 -	01177
1/2	- 7	01020	1 7/8	2 4	01064	3 1/4	2 11	01108	4 5/8	5 4	01152	6	6 -	01178
9/16	- 7	01022	1 15/16	2 2	01066	3 5/16	5 4	01110	4 11/16	5 4	01154	6 1/16	6 -	01179
5/8	- 8	01024	2	3 13	01068	3 3/8	4 11	01112	4 3/4	5 5	01156	6 1/8	6 1	01185
11/16	- 8	01026	2 1/16	3 8	01070	3 7/16	4 11	01114	4 13/16	5 6	01158	6 3/16	6 1	01186
3/4	- 9	01028	2 1/8	3 13	01072	3 1/2	4 12	01116	4 7/8	5 6	01160	6 1/4	6 2	01187
13/16	- 8	01030	2 3/16	1 10	01074	3 9/16	2 5	01118	4 15/16	5 7	01161	6 5/16	6 2	01188
7/8	- 12	01032	2 1/4	2 7	01076	3 5/8	3 13	01120	5	5 8	01162	6 3/8	6 3	01189
15/16	- 12	01034	2 5/16	2 7	01078	3 11/16	3 15	01122	5 1/16	5 8	01163	6 7/16	6 3	01190
1	- 13	01036	2 3/8	2 8	01080	3 3/4	4 8	01124	5 1/8	5 10	01164	6 1/2	6 3	01191
1 1/16	- 12	01038	2 7/16	2 8	01082	3 13/16	3 12	01126	5 3/16	5 10	01165	6 9/16	6 4	01192
1 1/8	- 15	01040	2 1/2	2 10	01084	3 7/8	4 2	01128	5 1/4	5 11	01166	6 5/8	6 4	01193
1 3/16	- 15	01042	2 9/16	2 14	01086	3 15/16	3 12	01130	5 5/16	5 11	01167	6 11/16	6 4	01194
1 1/4	1 3	01044	2 5/8	2 15	01088	4	4 12	01132	5 3/8	5 12	01168	6 3/4	6 5	01195
1 5/16	1 5	01046	2 11/16	2 15	01090	4 1/16	4 5	01134	5 7/16	5 12	01169	6 13/16	6 5	01196
1 3/8	1 9	01048	2 3/4	3 1	01092	4 1/8	3 14	01136	5 1/2	5 13	01170	6 7/8	6 5	01197
1 7/16	1 9	01050	2 13/16	2 8	01094	4 3/16	4 6	01138	5 9/16	5 13	01171	7	6 6	01199

**MILLIMETERS** stock sizes shown below:

Diameter (mm)	Weight ea (lbs) (oz)	UPC No.	Diameter (mm)	Weight ea (lbs) (oz)	UPC No.	Diameter (mm)	Weight ea (lbs) (oz)	UPC No.	Diameter (mm)	Weight ea (lbs) (oz)	UPC No.	Diameter (mm)	Weight ea (lbs) (oz)	UPC No.
2	- 3	01204	14	- 6	01228	26	1 -	01252	38	2 -	01276	50	3 12	01300
3	- 3	01206	15	- 8	01230	27	1 -	01254	39	2 -	01278	51	4 -	01302
4	- 3	01208	16	- 8	01232	28	1 2	01256	40	1 13	01280	52	4 -	01304
5	- 3	01210	17	- 9	01234	29	1 2	01258	41	2 12	01282	53	4 -	01306
6	- 3	01212	18	- 9	01236	30	1 2	01260	42	2 12	01284	54	4 8	01308
7	- 3	01214	19	- 11	01238	31	1 6	01262	43	3 -	01286	55	4 8	01310
8	- 3	01216	20	- 10	01240	32	1 4	01264	44	3 -	01288	56	4 12	01312
9	- 5	01218	21	- 12	01242	33	1 6	01266	45	3 -	01290	57	4 12	01314
10	- 5	01220	22	- 12	01244	34	1 6	01268	46	3 -	01292	58	5 -	01316
11	- 5	01222	23	- 12	01246	35	1 8	01270	47	3 8	01294	59	5 -	01318
12	- 5	01224	24	1 -	01248	36	1 10	01272	48	3 8	01296	60	5 -	01320
13	- 6	01226	25	1 -	01250	37	1 8	01274	49	3 12	01298			



These punches should be used on an Osborne No. #603 Cutting pad.  
The use of an Osborne wooden mallet or rawhide hammer is recommended.  
Steel hammers are not recommended.

## ARCH PUNCH SETS



### Osborne No. K-14

This set of seven arch punches includes the sizes most widely used. They are put up in a sturdy, easy to use canvas tool roll as shown.

1 each of following sizes Osborne No. 149 - Arch Punch:									Weight per set (lbs)	UPC No.
<b>K-14</b>	Sizes (inches)	1/4	3/8	1/2	5/8	3/4	7/8	1	4	01180

### Osborne No. K-14MM

This set of seven arch punches includes the most popular millimeter sizes. They are put up in a sturdy, easy to use canvas tool roll as shown.

1 each of following sizes Osborne No. 149mm - Arch Punch:									Weight per set (lbs)	UPC No.
<b>K-14MM</b>	Sizes (mm)	6	8	10	12	16	20	25	2 1/2	01179



### Osborne No. K-16

This set of seven arch punches of sixteenth sizes are incremented by 1/8" starting with 3/16". They are put up in a sturdy, easy to use canvas tool roll as shown.

1 each of following sizes Osborne No. 149 - Arch Punch:									Weight per set (lbs)	UPC No.
<b>K-16</b>	Sizes (inches)	3/16	5/16	7/16	9/16	11/16	13/16	15/16	4	01181

## BELT PUNCH SET

### Osborne No. K-245



Kit contains 1 each of Belt punches in the following sizes:  
1/8", 5/32", 3/16", 1/4", 5/16" and 3/8".  
Punches are packed in a sturdy plastic pouch.  
Weight per set: 13 oz.  
UPC No. 01520

## BELT PUNCH SET - Large sizes

### Osborne No. K-245 L



Kit contains 1 each of Belt punches in the following sizes:  
1/2", 9/16", 5/8", 3/4", 7/8" and 1".  
Punches are packed in a canvas tool roll.  
Weight per set: 4 lb. 12 oz.  
UPC No. 01524.

## MINI-PUNCH SET



### Osborne No. K-157

A special punch set for cutting small, precise holes in soft materials where throated or plier punches won't reach. Set has a round handle with slot inside to clear punchings. Handle is threaded to accommodate the seven replaceable screw tubes which are shown at left. See page 7 for actual size tube chart. Set consists of seven tubes and handle. Replacement handle **Osborne No. K157-H** is also available as well as the tubes **Osborne No. 153T**.

Tube size No.	0	1	2	3	4	5	6	Weight per set (oz)	UPC No.
Tube size (inches)	5/64	3/32	7/64	1/8	5/32	11/64	3/16	8	01860

## SELF-CENTERING PUNCH SET



### Osborne No. K-156

This handy and versatile kit contains threaded handle with self-centering pointed plunger. The threaded handle will accommodate nine inter-changeable threaded cutting tubes. The punches in this set will cleanly cut leather, rubber, paper, plastics and other soft materials. The self-centering point makes these punches ideal for cutting concentric washers in small quantities by hand. Sizes of punches listed below. All cutting edges properly hardened. Comes in a sturdy plastic box for storage.

Tube sizes (inches)								Weight per set (lbs)	UPC No.	
1/4	5/16	3/8	7/16	1/2	5/8	3/4	7/8	1	2 1/4	01870

#### REPLACEMENT PARTS

Osborne No.	Description	UPC No.	Osborne No.	Description	UPC No.
K156-H	Extra handle	01872	K-156T 1/2	Extra tube	01888
K-156T 1/4	Extra tube	01880	K-156T 5/8	Extra tube	01890
K-156T 5/16	Extra tube	01882	K-156T 3/4	Extra tube	01892
K-156T 3/8	Extra tube	01884	K-156T 7/8	Extra tube	01894
K-156T 7/16	Extra tube	01886	K-156T 1	Extra tube	01896

## CUTTING PAD



### Osborne No. 603

Made with a special formula of resilient vinyl, these tough cutting pads are designed for use with Osborne punches. They are long wearing and can be used on both sides. Cutting pads should be used on a solid base for best results. The semi-self healing surface absorbs cuts and helps prevent damage to the cutting edge of the punch.

Size (inches)	Weight ea (lbs) (oz)	UPC No.
10 x 10 x 3/8	2 4	67692

## OBLONG PUNCH



### Osborne No. 400

Polished barrel with hardened cutting edge. Hole tapers inside for easy punching clearings.

Size No.	Size (inches)	Weight ea (oz)	UPC No.
1	11/16 x 3/16	5	01644
2	7/8 x 1/4	6	01646



These punches should be used on an Osborne No. #603 Cutting pad.  
The use of an Osborne wooden mallet or rawhide hammer is recommended.  
Steel hammers are not recommended.

## ROUND OR DRIVE PUNCH

### Osborne No. 147



These Drive Punches are **drop forged** from finest special carbon steel, carefully hardened, with polished barrel. The hole tapers back from the cutting edge so that the punchings clear freely.

Actual Size																	
Size No.	0	1	2	3	4	5	6	7	8	9	10	11	12	13	14	15	16
Diameter Size	5/64	7/64	1/8	9/64	5/32	11/64	3/16	7/32	1/4	9/32	5/16	3/8	13/32	7/16	15/32	33/64	9/16
Weight ea (oz)	2	2	2	2	2	2	2	3	3	3	3	4	4	6	6	7	9
UPC No.	51410	51412	51414	51416	51418	51420	51422	51424	51426	51428	51430	51432	51434	51436	51438	51440	51442

## BELT PUNCH - Round shank

### Osborne No. 245



Hardened cutting edge - milled clearing hole.  
Available in imperial and metric sizes.

#### Inches

Size No.	00	0	1	2	3	4	5	6	7	8	9	10	11	12	13	14
Actual size																
Diameter (inches)	1/16	5/64	3/32	1/8	9/64	5/32	11/64	3/16	13/64	7/32	1/4	17/64	9/32	5/16	11/32	3/8
Weight (oz)	1	1	1	1	1	1	1	1	1	1	1	3	3	3	4	4
UPC No.	51460	51462	51464	51666	51468	51470	51472	51474	51476	51478	51480	51482	51484	51486	51488	51490

Size No.	15	16	1/2	9/16	5/8	3/4	13/16	7/8	22
Actual size									
Diameter (inches)	13/32	7/16	1/2	9/16	5/8	3/4	13/16	7/8	1
Weight (oz)	4	4	7	9	9	12	13	13	15
UPC No.	51492	51494	51496	51500	51498	51536	51538	51540	51542

#### Metric

Actual size											
Diameter (mm)	2	3	4	5	6	7	8	9	10	11	12
Weight (oz)	1	1	1	1	1	1	1	1	1	1	1
UPC No.	51502	51504	51506	51508	51510	51512	51514	51516	51518	51520	51522
Actual size											
Diameter (mm)	13	14	15	16	18	20					
UPC No.	51524	51526	51528	51530	51534	51538					



## FORGED REVOLVING PUNCH

For professional and industrial use

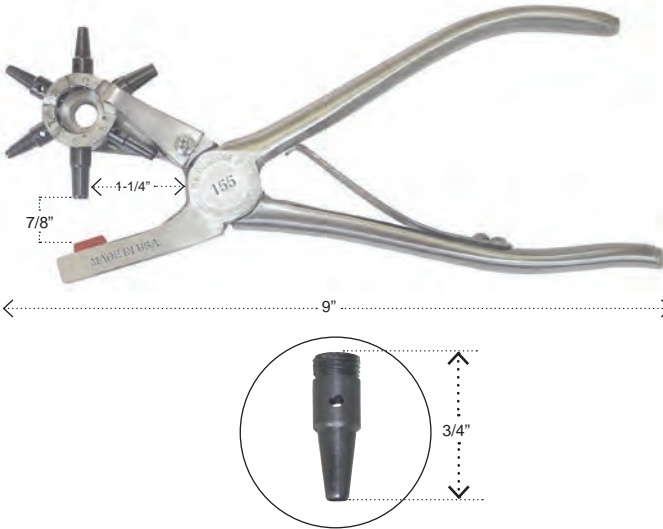

Replacement punch tube

### Osborne No. 155 1-6

This punch is the best Revolving Punch made. Six tube punch made with tubes sizes 1, 2, 3, 4, 5, & 6. The frame is made of forged steel, highly polished. Cutting tubes are turned from special carbon tool steel and threaded to allow easy replacement. Copper anvil. Each tube is individually hardened. The throat distance from the cutting tube to the back of jaw is 1 1/4".

Osborne No.	Description	Weight ea. (oz.)	UPC No.
<b>155 1-6</b>	Revolving Punch	15	52010
<b>155-A</b>	Extra anvil	1	52052
<b>155-HS</b>	Extra handle spring	1	02070
<b>155-SP</b>	Extra side spring	1	02072
<b>155T-(size)</b>	Extra tube (specify size)	1	-----
<b>155T 1-6</b>	Set of replacement tubes	2	02046

**Note:** Replacement tubes sizes 00, 0 & 7 are also available.

## REVOLVING PUNCH - Nickel Plated

### Osborne No. 223

A fine quality pressed steel frame revolving punch with drive tubes. All tubes are heat treated to give long wear. Furnished with tubes sizes: 0 (5/64"), 1 (3/32"), 2 (7/64"), 3 (1/8"), 4 (5/32") & 6 (3/16").



PACKED ON A DISPLAY CARD 11" x 4".

Osborne No.	Description	Weight ea. (oz.)	UPC No.
<b>223</b>	Revolving Punch	6	02290
<b>223T-0</b>	Replacement tube 5/64"	1	52222
<b>223T-1</b>	Replacement tube 3/32"	1	52224
<b>223T-2</b>	Replacement tube 7/64"	1	52226
<b>223T-3</b>	Replacement tube 1/8"	1	52228
<b>223T-4</b>	Replacement tube 5/32"	1	52230
<b>223T-6</b>	Replacement tube 3/16"	1	52234

## PUNCH TUBES SIZE CHART

Size No.	0	1	2	3	4	6
Diameter size	5/64	3/32	7/64	1/8	5/32	3/16
Actual size	●	●	●	●	●	●
UPC No.	52024	52026	52028	52030	52032	52036

**Note:** Numbers 155 and 223 punch tubes are not interchangeable.



## RIVETS SETTERS

### INSTRUCTIONS

Choose the rivet setter with a hole diameter slightly larger than the rivet being set. Sizes for #170 correspond with popular 8, 9 and 10 copper rivets. For other size rivets, use above table to determine proper size of #169 Rivet Setter. Push the rivet through the hole then turn the material over. Place burr on rivet, then use the rivet setting tool's straight hole to drive the burr down tight against the material. Cut the rivet off close to the burr with side or end nippers. Do not cut off flush with the burr, but leave about 1/16 of an inch above the burr. The hole on the side of the rivet setter can be used to dislodge any waste that is wedged into the tool. Place the concave recess of setter on the burr. Hold perpendicular and strike the tool forcefully, turning to the left then right as you strike. This spreads the end of the rivet over the burr, simultaneously rounding its end. A few extra blows from the # 57 riveting hammer can be used to flatten the rivet end a bit, if desired.

### Osborne No. 1700

**COPPER RIVETS** and burrs. Use with Osborne Nos. 169 & 170. 1 lb. box.



Size number	8	9	10	12	14
Diameter under head (inches)	.181	.161	.151	.137	.102
Overall length (inches)	3/4	3/4	3/4	3/4	3/4
Approx. number of rivets & burrs per lb.	100	125	152	186	314
Tool to be used	170-8	170-9	170-10	169-6	169-8
UPC No.	67278	67279	67280	67282	67284

### Osborne No. 169

Polished face, forged steel. Hardened working end.



#### TINNER'S RIVET SETTER

Osborne No.	Hole Dia.	Copper Rivet	Iron Rivet	Weight ea (oz)	UPC No.	Osborne No.	Hole Dia.	Copper Rivet	Iron Rivet	Weight ea (oz)	UPC No.
169-00	.313	-	14	15	67222	169-4	.166	9	2-1/2, 3	5	67232
169-0	.281	5	10,12	15	67224	169-5	.149	10, 11	1-3/4, 2	5	67234
169-1	.234	6	6	9	67226	169-6	.141	12	1-1/2	5	67236
169-2	.213	7	7	9	67228	169-7	.125	13	1-1/4	5	67238
169-3	.191	8	4, 5	9	67230	169-8	.109	14	10, 12	5	67240

### Osborne No. 170

Polished face, forged steel. Hardened working end.



#### FARMER'S RIVET SETTER

Osborne No.	Hole Dia.	Copper Rivet	Rivet Shank Dia.	Weight ea (oz)	UPC No.
170-8	.191	8	.181	5	67252
170-9	.171	9	.161	5	67254
170-10	.161	10	.151	5	67256

## RIVET SETTER



### Osborne No. 443

For use with loose leaf binders.

Overall length (inches)	Shank diameter (inches)	Weight ea. (oz).	UPC No.
4	3/8	2	67352

## RIVET SETTER



### Osborne No. 168

Rivet setter with concave end and knurled handle.

Overall length (inches)	Shank diameter (inches)	Weight ea. (oz).	UPC No.
3 7/8	3/8	2	67220

## EYELET SETTER



### Osborne No. 456 & 24-24

Spreads eyelets so that they can be flattened with a mallet or rawhide hammer. Knurled handle prevents slipping. Nickel plated.

Osborne No.	Overall length (inches)	Shank diameter (inches)	Weight ea. (oz).	UPC No.
456	4 3/8	5/16	1	67402
24-24	4 3/8	1/4	1	67400

## EYELET SETTER



### Osborne No. 257

Enables eyelets to be set in a paper card without preparation. Pierces material and sets 5/32" and 1/4" in a single operation. 2 sizes.

Osborne No.	Overall length (inches)	For eyelets size (inches)	Weight ea. (oz).	UPC No.
257 5/32	8 1/2	5/32	7	17292
257 1/4	8 1/2	1/4	7	17294



## CANING CHISEL



### Osborne No. 405

Hardened and tempered steel. Available in two sizes to fit groove size. Has a translucent cellulose acetate handle. Carded for display.

Osborne No.	Blade length (inches)	Blade width (inches)	Overall (inches)	Weight ea(oz)	UPC No.
405 1/8	4	1/8	8	3	53222
405 3/16	4	3/16	8	3	53224

## CANING NEEDLE

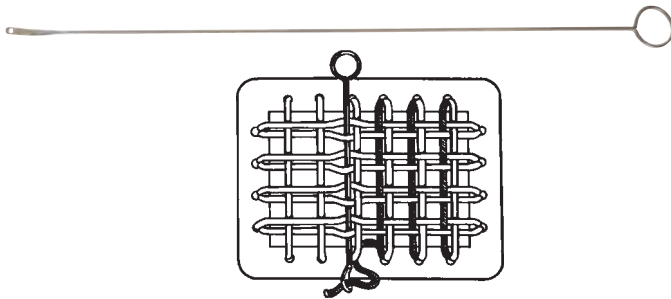

### Osborne No. 407

NICKEL PLATED. Makes weaving in the strands faster and easier. Snake the needle through the strands, thread the eye and pull needle across the frame.

Overall length (inches)	Size of eye (inches)	Weight (oz)	UPC No.
21	1/8 x 3/32	1	64338

Weaving strands with the Osborne No. 407 Needle

## CANING TOOL



### Osborne No. 406

This Caning Tool can be used to move individual or multiple canes during any stage of the caning process by hooking one or both pins behind the cane and pulling it into position. This tool makes caning easier with less repetitive motion and lighter finger load.

Overall length (inches)	Weight ea. (oz)	UPC No.
5-1/4	1	64336

PATENT PENDING

## BASKET WEAVING TOOL WITH EYE



### Osborne No. 423 & 423-L

Hardwood handle. Ideal for work in the more confining space of basket weaving. Also available with bigger eye Osborne No. 423-L.

Osborne No.	Overall length (inches)	Size of the eye (inches)	Weight ea. (oz)	UPC No.
423	7-3/4	1/8 x 3/32	1	64339
423-L	7-3/4	3/8 x 5/16	1	64346

## BASKET WEAVING TOOL



### Osborne No. 424-S

Stainless steel with straight blade. Round polished hardwood handle. Ideal for working in water.

Blade length (inches)	Overall length (inches)	Weight ea (oz)	UPC No.
3 3/8	7	1	64337



### Osborne No. 424-B

Stainless steel with bent blade. Round polished hardwood handle. Ideal for working in water.

Blade length (inches)	Overall length (inches)	Weight ea (oz)	UPC No.
3 1/8	7	1	64335



## GENUINE BONE FOLDER, TRADITIONAL



### Osborne No. 464

Highly polished genuine cattle bone folder for pasting and folding. Also for burnishing Latrone sheets, lettering, gold leaf etc. Ideal size for best results.

Overall length (inches)	Weight ea. (oz)	UPC No.
6-1/4	1	67478

## GENUINE BONE FOLDER, STRAIGHT



### Osborne No. 727A

Straight real high polished cattle bone folder for pasting and folding. Also for burnishing Latrone sheets, lettering, gold leaf, etc. Available in three different sizes.

Osborne No.	Overall length (inches)	Weight ea. (oz)	UPC No.
<b>727A/15</b>	6	1	14664
<b>757A/18</b>	7-1/8	2	14666
<b>727A/20</b>	8	2	14668

## SYNTHETIC BONE FOLDER

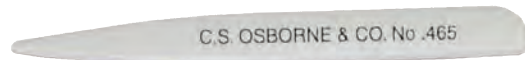

### Osborne No. 465

This bone folder is similar to our No. 464 Bone Folder except that it is made of polished nylon.

Overall length (inches)	Weight ea. (oz)	UPC No.
6-1/4	1	67484

## BENT BONE FOLDER

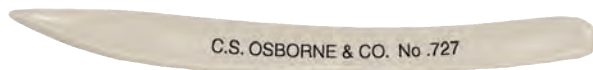

### Osborne No. 727

Bent real high polished cattle bone folder for pasting and folding. Also for burnishing Latrone sheets, lettering, gold leaf, etc.

Osborne No.	Overall length (inches)	Weight ea. (oz)	UPC No.
<b>727/15</b>	6	1	14658
<b>757/18</b>	7-1/8	2	14660
<b>727/20</b>	8	2	14662



## HEAVY DUTY SCRATCH AWL



### Osborne No. 4

Made in four sizes for your convenience. Best quality steel blades with rugged amber translucent cellulose acetate handles.

Size No.	Blade length (inches)	Overall length (inches)	Weight ea (oz)	UPC No.
1	2 1/2	4 1/2	1	62012
2	3 1/2	5 1/2	2	62014
3	4 1/2	6 3/4	3	62016
4	5 1/2	7 3/4	4	62018

## SCRATCH AWL



### Osborne No. 478

Sharp pointed. Tempered blade for piercing leather, sewing and a variety of uses. Hardwood handle.

Blade length (inches)	Overall length (inches)	Weight ea (oz)	UPC No.
2	3 7/8	1	62022

## SCRATCH AWL



### Osborne No. 911-PK

Hardened steel square pointed. Plastic handle. UPC. No. 65148.

Blade length (inches)	Overall (inches)	Weight ea. (oz)	UPC No.
4	7 1/2	3	65148

## SCRATCH AWL



### Osborne No. 604-S

Straight point blade across the handle. Use for striking with a mallet.

Blade length (inches)	Overall (inches)	Weight ea (oz)	UPC No.
4-5/8	6-1/2	2	60056

## BADMINTON AWL



### Osborne No. T-10

Sharp point. Hardwood handle.

Blade length (inches)	Overall length (inches)	Weight ea (oz)	UPC No.
1 1/4	5	1	62032

## TENNIS AWL



### Osborne No. T-11

Blunt point prevents scratching the material when aligning, etc. Hardwood handle.

Blade length (inches)	Overall length (inches)	Weight ea (oz)	UPC No.
2 1/2	6 1/4	1	62042

## ALL PURPOSE AWL



### Osborne No. 18

Nickel plated. Durable fluted handle. The bent awl is a varied-purpose tool. Great for hard to reach places in upholstery work. Can be used to remove small staples in grooves. Tempered end.

Blade length (inches)	Overall length (inches)	Weight ea (oz)	UPC No.
5 1/2	9 1/2	4 1/2	62052

**AUTOMATIC AWL**



**Osborne No. 413**

An unusual tool for sewing leather, canvas and similar materials. The awl carries a spool of waxed polyester black thread on the handle. Hollow handle holds an extra curved needle and wrench. Directions furnished with each awl explaining how automatic awl lock stitch can be effected in repair work. Furnished with one straight (Osborne No. 413N 8) and one curved diamond point (Osborne No. 413N 6) needle.

Weight each 3 oz.

UPC No. 62142



Straight Needle

Curved Needle



Osborne No. 413ST 1/4 lb. tube of thread 185 yards.



Osborne No. 413R reel of thread 12½ yards. Waxed polyester strand (0.27mm diameter).

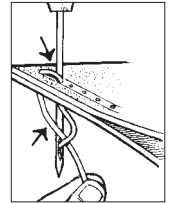
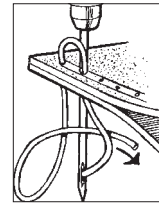
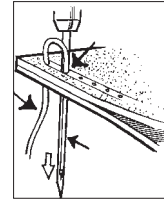
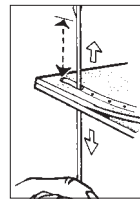
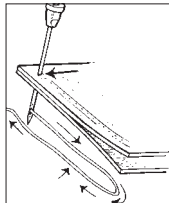

**REPLACEMENT PARTS**

Osborne No.	Description	UPC No.
413N 5	Short straight needle	62192
413N 6	Curved needle	62194
413N 8	Coarse straight needle	62196
413R B	Reels of black thread	62182
413R BR	Reels of brown thread	62184
413R W	Reels of white thread	62186
413ST B	Black thread 1/4 lb. tube	12162
413ST BR	Brown thread 1/4 lb. tube	12164
413ST W	White thread 1/4 lb. tube	12166

**HAFT WITH AWL INSERTED**



C.S. OSBORNE & CO. No 140

**Osborne No. 140**

Finest quality, Spring steel awl. Sharp end curved end point. Also available with Osborne No. 32 3 already inserted **No. 140-32**.

Blade length (inches)	Overall length (inches)	Weight ea. (oz)	UPC No.
1-1/4	4-3/4	1	62228

**AWL HAFT**



C.S. OSBORNE & CO. No 140-H

**Osborne No. 140-H**

Made of hardwood. Designed to fit the palm of your hand. Light weight with ring for easy use of thumb for precise stitching. UPC No. 62232.

**AWL HAFT**



C.S. OSBORNE & CO. No. 141

Knurled chuck

**Osborne No. 141**

Lacquer finish, brass chuck designed to hold thick awls or wider needles. Knurling on chuck makes it easy to tighten manually. Narrow neck is correct size for one or two turns of thread. Weighs 2 oz. UPC No. 62208



**PALM AWL HAFT**



C. S. OSBORNE & CO. No. 142

**Osborne No. 142**  
Made of lacquered hardwood. Comes with steel chuck and wrench. Shaped to fit in hand. Weighs 2 oz. UPC No. 62210.

**PEG AWL HAFT**



C. S. OSBORNE & CO No. 143

**Osborne No. 143**  
Made with chuck and wrench to permit easy changing of blades. Leather tipped to prevent splitting when hammered. Lacquered hardwood handle. Weighs 2 oz. UPC No. 62212.

**SHOE AWL HAFT**



C.S. OSBORNE & CO. No. 144

**Osborne No. 144**  
Clear lacquer finish, brass ferrule. Holds awls No. 32, 43, 44 and also needle No. 504-4. Also available with awl No. 32 **Osborne No. 144-32** already inserted & with awl No. 43 **Osborne No. 144-43**.

**SEWING AWL HAFT**



C.S. OSBORNE & CO. No. 145

**Osborne No. 145**  
Knobbed end permits easy grasp and prevents slipping. Also made for wrapping thread. Made of hard maple. Varnished. Comes with chuck and wrench. Weighs 2 ounces. Holds all Osborne awls shown below. UPC No. 62224.

**SEWING AWL HAFT**



Knurled chuck → C.S. OSBORNE & CO. No. 928

**Osborne No. 928**  
A popular sewing awl haft in Europe. Knurled chuck makes it easy to tighten manually. Weighs 2 oz. UPC No. 65150.

**C.S. Osborne Awl Blades are the finest in the world. Made from premium steel and hand finished.**

**CURVED DOUBLE POINT AWL**



Diamond point

**Osborne No. 40**  
Finest quality. 3-1/2" long. UPC No. 62098. Packed and sold by dozen.

**CURVED ROUND POINT AWL**



Round point

**Osborne No. 140-A**  
Finest quality. 2-3/8" long. UPC No. 62230. Packed and sold by dozen.

**CURVED SEWING AWLS**



Flat point

Finest quality.

**Osborne No. 31**  
Available in 3 sizes. Packed and sold by dozen. Specify when ordering.

Size (inches)	2 1/2	3	3 1/2
UPC No.	62082	62084	62086

**STABBING AWLS, ROUND POINT**



Round point

**Osborne No. 32**  
Finest and toughest steel. Available in 2 sizes: 2-1/2" UPC No. 62092 and 3" UPC No. 62094.

**SADDLERS' HARNESS AWL**



Diamond point

Finest quality. Special thin sizes.

Osborne No.	42	43	44	45	46	47	48	49	50-H	52
Size (inches)	1 1/2	1 3/4	2	2 1/4	2 1/2	2 5/8	2 3/4	2 7/8	3	3 1/4
UPC No.	62100	62102	62104	62106	62108	62110	62112	62114	62116	62118

**SADDLERS' STITCHING AWL**



Diamond point

Osborne No.	54	56	57	58	59
Size (inches)	2	2 1/4	2 1/2	2 3/4	3
UPC No.	62120	62122	62124	62126	62128

## SAIL PALM



### Osborne No. 265

Rawhide palm with bound iron-thimble. Riveted joints. Made in both right and left hand. Right hand will be furnished unless otherwise specified.

Osborne No.	Description	Weight each (oz)	UPC No.
<b>265-RH</b>	Sail palm right hand	2 1/2	67322
<b>265-LH</b>	Sail palm left hand	2 1/2	67324

## SEWING PALM



### Osborne No. 266

A rawhide bound, iron-thimble palm with riveted joints. Furnished either in right or left hand. Right hand will be furnished unless otherwise specified.

Osborne No.	Description	Weight each (oz)	UPC No.
<b>266-RH</b>	Sail palm right hand	2 1/2	67332
<b>266-LH</b>	Sail palm left hand	2 1/2	67334

## OPEN END THIMBLE



### Osborne No. 510

Nickel plated brass thimbles. Coarse grate. 7 sizes available.

Osborne No.	Inside diameter of base (mm)	Weight each (oz)	UPC No.
<b>510-5</b>	13.2	1	67650
<b>510-7</b>	14	1	67662
<b>510-9</b>	14.5	1	67660
<b>510-10</b>	15.4	1	67658
<b>510-11</b>	16	1	67656
<b>510-12</b>	17	1	67654
<b>510-13</b>	18	1	67652

## CLOSED END THIMBLE



### Osborne No. 511

Nickel plated brass thimbles. Coarse grate. 7 sizes available.

Osborne No.	Inside diameter of base (mm)	Weight each (oz)	UPC No.
<b>511-5</b>	13.2	1	67684
<b>511-7</b>	14	1	67680
<b>511-9</b>	14.5	1	67682
<b>511-10</b>	15.4	1	67678
<b>511-11</b>	16	1	67676
<b>511-12</b>	17	1	67674
<b>511-13</b>	18	1	67672



**OSBORNE** needles and pins have long been considered a standard for fine quality. Experience and efficiency in the art of needle making for over one hundred and eighty five years have produced the dependable tools well known throughout the trade as **OSBORNE NEEDLES AND PINS.**

The uniform quality of our needles and pins is carefully maintained by the consistent efforts of the skillful crafts people who make them.

**QUOTATION FOR SPECIAL NEEDLES AVAILABLE UPON REQUEST.**

**OSBORNE** needles are gauged by the Standard Wire Gauge as the table illustrates. The gauge sizes are also listed in thousandths of an inch and millimeter sizes.

### OSBORNE NEEDLE GAUGES

Actual diameter of wire	English gauge	Decimal equiv. (inch)	Decimal equiv. (mm)
	5	.212	5.385
	5 1/2	.202	5.130
	6	.192	4.877
	7	.176	4.470
	7 1/2	.168	4.267
	8	.160	4.064
	9	.144	3.658
	10	.128	3.251
	11	.116	2.946
	11 1/2	.110	2.794
	12	.104	2.642
	13	.092	2.337
	14	.080	2.032
	15	.072	1.829
	16	.064	1.626
	17	.056	1.422
	18	.048	1.219
	19	.040	1.016
	20	.036	0.914
	21	.032	0.813
	22	.028	0.711
	23	.024	0.610

Curved needles are listed in this catalogue according to length (over all) from eye to point. The bottom lines in the following table of measurements also gives the shortest distance (across) from eye to point.

2	2 1/2	3	3 1/2	4	5	6	7	8	9	10	inches over all
1 1/2	1 3/4	2	2 3/8	2 3/4	3 3/8	4	4 3/4	5 1/4	6	6 3/4	inches across

### STRAIGHT DOUBLE 3 SQUARE POINT - Needle Kit

#### Osborne No. K-8

3 straight double triangular point needles sizes 10", 12" & 14" to a card. Each card printed in attractive yellow and blue and sealed in plastic pouch. Kalamazoo hole for hang up display.



Kits per box	Weight per box (oz)	UPC No.
12	18	15008



All cellophane and plastic used on Osborne needle cards is biodegradable.

## HOUSEHOLD REPAIR KIT



### Osborne No. K-1

The hallmark blue and yellow case contains an assortment of professional grade needles. Useful in all applications but "hard-to-find" at your regular source of supply. Kalamazoo hole for hang up display. Plastic covered.

Each Kit Contains:	
2 ea.	Curved upholstery needles.
1 ea.	Special bent needle for sewing up fowl sacks or wherever sewing with a string is needed.
1 ea.	Awning or canvas needle - (can be used on sails too).
1 ea.	Carpet or very heavy material needle.
Weight/box	16 oz.
UPC No.	15012

## STRAIGHT ROUND POINT



### Osborne No. K-5

Four straight round point needles sizes 6", 8", 10" and 12" to a card. Each card printed in attractive yellow and blue and is in sealed plastic pouch. Kalamazoo hole for hang up display.

Kits per box	Weight per box (oz)	UPC No.
12	18	15018

## STRAIGHT DOUBLE ROUND POINT



### Osborne No. K-6

3 straight double round point needles sizes 10", 12" & 14" to a card. Each card printed in attractive yellow and blue and sealed in plastic pouch. Kalamazoo hole for hang up display.

Kits per box	Weight per box (oz)	UPC No.
12	18	15010

## CURVED ROUND POINT



### Osborne No. K-3

4 round point needles in the followings sizes: 3", 4", 5" & 6" long to a card. Kalamazoo hole for hang up display. Plastic covered.

Kits per box	Weight per box (oz)	UPC No.
12	6	15014

## CURVED 3-SQUARE POINT



### Osborne No. K-4

4 three-square point needles in the followings sizes: 3", 4" 5" & 6" long to a card. Kalamazoo hole for hang up display. Plastic covered.

Kits per box	Weight per box (oz)	UPC No.
12	6	15016

## CURVED ROUND POINT X-LIGHT



### Osborne No. K-7

4 extra light round point needles in the followings sizes: 2 1/2", 3", 3 1/2" & 4" long to a card. Kalamazoo hole for hang up display. Plastic covered.

Kits per box	Weight per box (oz)	UPC No.
12	4	15020



Following cards are cellophane covered that is biodegradable.

## NEEDLE CARD



### Osborne No. K-10

Each kit contains 20 sewing needles, 10 Darners and 1 Threader. Kalamazoo hole for hang up display. Nickel plated.

Kits per box	Weight per box (oz)	UPC No.
12	4	15022

## NEEDLE CARD



### Osborne No. K-11

Each kit contains 25 assorted hand sewing needles. 10 each # 7, 10 each # 5 and 5 each # 3. Kalamazoo hole for hang up display. Nickel plated.

Kits per box	Weight per box (oz)	UPC No.
12	4	15028

## NEEDLE CARD



### Osborne No. K-12

Each kit contains 5 Chenille and 5 Tapestry needles. 1 each # 18, 2 each # 20 and 2 each # 22. Kalamazoo hole for hang up display. Nickel plated.

Kits per box	Weight per box (oz)	UPC No.
12	4	15034

## NEEDLE CARD



### Osborne No. K-15

Each kit contains 12 Assorted Darners needles, sizes 0/5. Kalamazoo hole for hang up display. Nickel plated. Kalamazoo hole for hang up display. Nickel plated.

Kits per box	Weight per box (oz)	UPC No.
12	4	15040



## CURVED 3 SQUARE POINT



Packed 12 needles per package.

### Osborne No. 502X EXTRA LIGHT

Size (in)	2	2 1/2	3	3 1/2	4
Gauge	21	20	19	18	18
UPC No.	15242	15244	15246	15248	15250

### Osborne No. 502 1/2 LIGHT

Size (in)	2	2 1/2	3	3 1/2	4	5	6	7	8
Gauge	19	18	18	17	16	16	15	15	15
UPC No.	15262	15264	15266	15268	15270	15272	15274	15276	15278

### Osborne No. 502 HEAVY

Size (in)	2	2 1/2	3	3 1/2	4	5	6	7	8	10
Gauge	17	17	16	16	15	14	14	14	13	13
UPC No.	15292	15294	15296	15298	15300	15302	15304	15306	15308	15310

## CURVED ROUND POINT



Packed 12 needles per package.

### Osborne No. 513X CORD, EXTRA LIGHT

Size (in)	2	2 1/2
Gauge	23	23
UPC No.	15192	15194

### Osborne No. 513 CORD LIGHT

Size (in)	2	2 1/2
Gauge	19	19
UPC No.	15196	15198

### Osborne No. 501X EXTRA LIGHT

Size (in)	2	2 1/2	3	3 1/2	4
Gauge	21	20	19	18	18
UPC No.	15112	15114	15116	15118	15120

### Osborne No. 501 1/2 LIGHT

Size (in)	2	2 1/2	3	3 1/2	4	5	6	7	8
Gauge	19	18	18	17	16	16	15	15	15
UPC No.	15132	15134	15136	15138	15140	15142	15144	15146	15148

### Osborne No. 501 HEAVY

Size (in)	2	2 1/2	3	3 1/2	4	5	6	7	8	10
Gauge	17	17	16	16	15	14	14	14	13	13
UPC No.	15162	15164	15166	15168	15170	15172	15174	15176	15178	15180

## LAMPSHADE - ROUND POINT



Packed 12 needles per package.

### Osborne No. 741

Size (in)	2	2 1/2	3	3 1/2	4
Gauge	21	21	21	19	19
UPC No.	15212	15214	15216	15218	15220

## CURVED "LEATHER POINT"



Packed 12 needles per package.

### Osborne No. 503 LIGHT

Size (in)	2	2 1/2	3	3 1/2	4	5	6	8
Oval gauge	19	19	16	16	15	15	14	13
Flat gauge	23	23	19	19	19	19	17	17
UPC No.	15322	15324	15326	15328	15330	15332	15334	15336

### Osborne No. 553 HEAVY

Size (in)	3	4	5	6	7	8
Oval gauge	15	14	13	13	12	12
Flat gauge	18	17	17	17	14	14
UPC No.	15342	15344	15346	15348	15350	15352

## CURVED MATTRESS NEEDLE - LONG BAYONET POINT



Packed 12 needles per package.

### Osborne No. 409

Similar to Osborne No. 503 but with sharp hand polished edges.

Size (in)	4	8
Gauge	15	14
UPC No.	15232	15234

## SILK / BILLIARD NEEDLE Round point

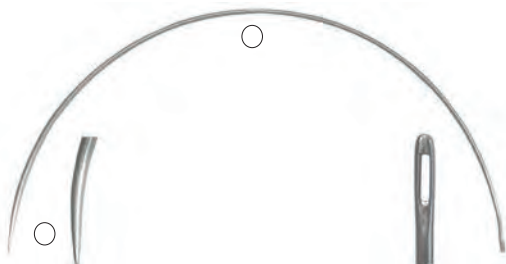

Packed 12 needles per package.

### Osborne No. 521-40MM

Available only in one size.

Size (in)	2
Gauge	23
UPC No.	24260

## WEAVING NEEDLES

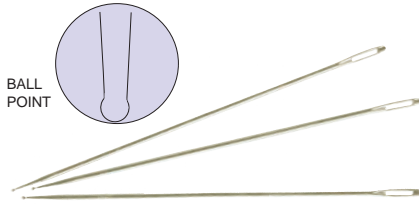

Packed 25 needles per package.

### Osborne No. 52248

These needles have a rounded tip, so they're perfect for sewing on knit fabrics. A sharp needle can easily damage knit fabric by poking through a thread and then pulling out the knit stitches. A ball point, on the other hand, will pass right through the knit. Available in variety of sizes and thickness. Specify when ordering.

#### BALL POINT - LIGHT

Size	37	40	44	48	55	62	68	72	76	90	100	110
Length (in)	1.46	1.57	1.73	1.89	2.17	2.44	2.68	2.84	3	3.50	4	4.3
Gauge	23	22	22	22	22	22	22	22	20	18	17	17
UPC No.	14900	14902	14904	14906	14908	14910	14912	14914	14916	14918	14920	14922

#### BALL POINT - HEAVY

Size	000	002	3/0	5/0	7/0	125
Length (in)	2.91	2.68	3.07	3.54	4.72	4.92
Gauge	18	18	17	16	16	14
UPC No.	14924	14926	14928	14930	14932	14934

### Osborne No. 52247

Size	057
Length (in)	2.25
Gauge	18
UPC No.	14910

FOR  
NYLON

## COLLAR NEEDLES - Half moon



Packed 12 needles per package.

### Osborne No. 92 1/2

Size (in)	3	3 1/2	4	5	6	6 1/2	7 1/2	8 1/2
Gauge	12	11	10	9	9	7	6	7
UPC No.	15876	15880	15882	15878	15884	15886	15888	15890

## STAINLESS STEEL SERPENTINE NEEDLES



Packed 12 needles per package.

### Osborne No. 523

Fine quality stainless steel needle. Triangular sharp cutting edge. Great for sewing heavy hides where you need a good grip. 4 sizes available.

Osborne No.	Overall ((inches)	Flat Gauge	Oval Gauge	UPC No.
523 3-1/4	3 1/4	18	15	14942
523 4	4	16	16	14944
523 5-1/2	5 1/2	16	13	14946
523 6	6	15	13	14948

## STAINLESS STEEL LOOPUYTS NEEDLES

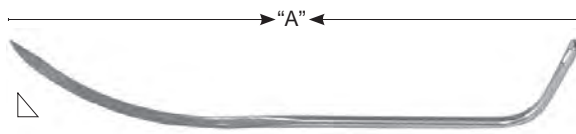

Packed 12 needles per package.

### Osborne No. 524

Fine quality stainless steel needle. Triangular sharp cutting edge. Nickel plated. Designed for good grip and ease in use. Won't wear your hands after hours of sewing. Great for light to heavy skins. 4 sizes available.

Osborne No.	Distance "A" (inches)	Flat Gauge	Oval Gauge	UPC No.
524-1	2 5/8	18	16	14950
524-2	2 1/4	19	18	14952
524-3	1 3/4	20	19	14954
524-4	1 1/2	20	19	14956
524-5	1 3/8	20	19	14958

## BIRD PELT NEEDLES



Packed 12 needles per package.

### Osborne No. 519

Fine quality steel. Curved triangular outside spine point. Ultra thin gauges. 2 sizes available.

Osborne No.	Overall ((inches)	Flat Gauge	Oval Gauge	UPC No.
519 1-1/2	1 1/2	23	20	15742
519 3	3	19	17	15744



### STRAIGHT SINGLE ROUND POINT



12 needles per package.

### Osborne No. 504

Size (in.)	4	5	6	8	10	12	14	16	18
Gauge	15	14	14	14	13	13	13	12	12
UPC No.	15362	15364	15366	15368	15370	15372	15374	15376	15378

### Osborne No. 554

Size (in.)	6	8	10	12	14	16	18
Gauge	13	13	12	12	12	11	11
UPC No.	15386	15388	15390	15392	15394	15396	15398

### BOLSTER NEEDLE - ROUND POINT



1 needle per package.

### Osborne No. 554-24

Size (in)	24
Gauge	11
UPC No.	15400

### STRAIGHT DOUBLE ROUND POINT



12 needles per package.

### Osborne No. 505

Size (in.)	6	8	10	12	14	16	18	20
Gauge	14	14	13	13	13	12	12	12
UPC No.	15412	15414	15416	15418	15420	15422	15424	15426

### Osborne No. 555

Size (in.)	6	8	10	12	14	16	18
Gauge	13	13	12	12	12	11	11
UPC No.	15432	15434	15436	15438	15440	15442	15444

### STRAIGHT SINGLE 3 SQUARE POINT



12 needles per package.

### Osborne No. 506

Size (in.)	6	8	10	12	14	16	18
Gauge	14	14	13	13	13	12	12
UPC No.	15452	15454	15456	15458	15460	15462	15464

### Osborne No. 556

Size (in.)	6	7	8	10	12	14	16	18
Gauge	13	13	13	12	12	12	11	11
UPC No.	15472	15473	15474	15476	15478	15480	15482	15484

### FLOCKING NEEDLES



12 needles per package.

### Osborne No. 514

Size (in.)	6	7	7	8	8	10
Gauge	12	12	11	12	11	11
UPC No.	15632	15634	15636	15638	15640	15642

### STRAIGHT DOUBLE 3 SQUARE POINT



12 needles per package.

### Osborne No. 507

Size (in.)	6	8	10	12	14	16	18
Gauge	14	14	13	13	13	12	12
UPC No.	15492	15494	15496	15498	15500	15502	15504

### Osborne No. 557

Size (in.)	6	8	10	12	14	16	18	20
Gauge	13	13	12	12	12	11	11	11
UPC No.	15512	15514	15516	15518	15520	15522	15524	15526



Osborne upholsterer's needles have long been considered the world standard for fine quality. These needles are manufactured from the finest wire to Osborne exacting quality.

## HARNES NEEDLES



### Osborne No. 517

Packed 25 needles per paper.

Size No.	000	00	0	1	2	3	4	5	6	7
Length (in)	2 3/8	2 3/8	2 3/8	2 3/8	2 1/4	2 1/8	1 7/8	1 7/8	1 9/16	1 5/8
Gauge	16	17	18	19	19	20	20	21	21	22
UPC No.	15672	15674	15676	15678	15680	15682	15684	15686	15688	15690

## GLOVERS' NEEDLES



### Osborne No. 518

Packed 25 needles per paper.

Size No.	000	00	0	1	2	3	4	5	6	7
Length (in)	2 5/16	2 1/16	2	1 7/8	1 13/16	1 11/16	1 5/8	1 9/16	1 7/16	1 3/8
Gauge	17	17	18	18	18	19	19	20	20	22
UPC No.	15712	15714	15716	15718	15720	15722	15724	15726	15728	15730

## PEARL & BEAD STRINGING NEEDLES - Blunt point Osborne No. 559-5



Length (in)	Gauge	UPC No.
5	18	15700

Packed 25 needles per paper.

## PEARL & BEAD SEWING NEEDLES Osborne No. 561



Length (mm)	Gauge (mm)	UPC No.
30	0.40	15762
40	0.45	15764

Packed 25 needles per paper.

## TAPESTRY NEEDLES - Blunt point

### Osborne No. 563

NICKEL PLATED. Packed 25 needles per paper. 8 sizes available.



Size No.	13	14	16	18	20	22	24	26
Length (inches)	2 3/4	2 5/16	2 5/32	2	1 3/4	1 1/2	1 1/4	1 1/8
Gauge	13	14	16	18	20	22	24	26
Eye (inches)	11/16 x 1/16	5/8 x 1/16	1/2 x 3/64	1/2 x 3/64	1/4 x 1/16	1/4 x 1/16	1/4 x 1/32	3/16 x 1/32
UPC No.	15842	15844	15846	15848	15850	15852	15854	15856

## CHENILLE NEEDLES - Round point

### Osborne No. 562

NICKEL PLATED. Packed 25 needles per paper. 8 sizes available.



Size No.	13	14	16	18	20	22	24	26
Length (inches)	2 3/4	2 5/16	2 5/32	2	1 3/4	1 1/2	1 1/4	1 1/8
Gauge	13	14	16	18	20	22	24	26
Eye (inches)	11/16 x 1/16	5/8 x 1/16	1/2 x 3/64	1/2 x 3/64	1/4 x 1/16	1/4 x 1/16	1/4 x 1/32	3/16 x 1/32
UPC No.	15842	15844	15846	15848	15850	15852	15854	15856

## SMYRNA NEEDLES - Blunt point

### Osborne No. 565

NICKEL PLATED. Packed 25 needles per paper. 2 sizes available.



Size (inches)	Gauge	Length (inches)	Eye (inches)	UPC No.
1	12	2 3/4	43/64 x 1/16	15872
3	13	2 1/4	1/2 x 1/16	15874

## SMYRNA NEEDLES - Round point

### Osborne No. 564

NICKEL PLATED. Packed 25 needles per paper. 2 sizes available.



Size (inches)	Gauge	Length (inches)	Eye (inches)	UPC No.
1	12	2 3/4	43/64 x 1/16	15862
3	13	2 1/4	1/2 x 1/16	15864

## PEARL & BEAD STRINGING NEEDLES - Sharp point

### Osborne No. 560-SP

Length (mm)	Gauge (mm)	UPC No.
100	0.50	15752
125	0.65	15754
100	0.75	15756

## PEARL & BEAD STRINGING NEEDLES - Blunt point

### Osborne No. 560-BP

Length (mm)	Gauge (mm)	UPC No.
100	0.50	15753
125	0.65	15755
100	0.75	15757



## SAILMAKERS' AND CANVAS NEEDLES

### Osborne No. 509

Nickel plated

Triangular point



Size (Gauge)	9	10	12	13	14	15	16	17
Length (inches)	4	3 3/4	3 1/4	3	2 3/4	2 1/2	2 3/8	2 1/4
UPC No.	15612	15614	15618	15620	15622	15624	15626	15628

## BENT PACK NEEDLES

### Osborne No. 508

SIDE VIEW



Diamond point

Packed 12 needles per package.

TOP VIEW



Size (inches)	3	3 1/2	4	5	6	7	8	9	10
Gauge	14	13	12	10	9	7	6	5	4
UPC No.	15552	15554	15556	15558	15560	15562	15564	15566	15568

## STRAIGHT PACK NEEDLES

### Osborne No. 508 1/2



Diamond point

Size (inches)	4	5	6
Gauge	12	10	9
UPC No.	15572	15574	15576

Packed 12 needles per package.

## SPRING EYE STRAIGHT PACK NEEDLES WITH CUTTER - INSIDE EYE

### Osborne No. 508 1/2 SE

Highly polished by hand. Sharp edges. Flexible eye entry.

TOP VIEW



Packed 12 needles per package.



Diamond point

SIDE VIEW



CUTTER

Size (inches)	4	4 1/2	4	5	5	6	6
Gauge	7	7	8	5	7	5	7
UPC No.	15582	15581	15588	15583	15584	15585	15586

## CARPET NEEDLES

### ROUND POINT

### 3 SQUARE POINT



### Osborne No. 515

Size (inches)	1 7/8	2 1/8	2 1/2	3
Gauge	18	17	17	16
UPC No.	15652	15654	15656	15658



### Osborne No. 516



Size (inches)	2 1/8	2 1/2
Gauge	18	17
UPC No.	15664	15666

Packed 25 needles per package.

## UPHOLSTERERS' PINS



### Osborne No. 190

Nickel plated. Sold in 1 gross boxes. 4 sizes are available.

Osborne No.	Overall (inches)	Gauge	Weight per gross (oz)	UPC No.
190 2-1/2	2 1/2	16	7	15930
190 3	3	16	8	15932
190 3-1/2	3 1/2	16	10	15934
190 4	4	16	11	15936

### Osborne No. 190S

1/4 gross packing in gross boxes in sizes 3" and 3 1/2" only.

## T-PINS



### Osborne No. 189

Nickel plated. Packed 1/2 lb. to a box. 5 sizes are available.

Osborne No.	Length (inches)	Gauge	Approx. pcs/box	UPC No.
189-16	1	21	1300	15910
189-20	1 1/4	21	975	15912
189-24	1 1/2	19	450	15914
189-28	1 3/4	19	400	15915
189-32	2	19	350	15916

## DRESSMAKER'S PINS



### Osborne No. 198

High quality. Nickel plated. Solid head. Packed 1 lb. to a box. 6 sizes are available.

Osborne No.	Length (inches)	Gauge	Approx. pcs/box	UPC No.
198-16	1	22	6150	15980
198-17	1 1/16	21	4800	15982
198-20	1 1/4	20	2540	15984
198-24	1 1/2	19	2140	15986
198-28	1 3/4	18	1220	15988
198-32	2	18	1060	15990

## PLASTIC HEAD PINS



### Osborne No. 193

Nickel plated. Plastic heads are available in green, blue, red, yellow and white. Please specify color preference when ordering.

Osborne No.	Overall (inches)	Gauge	Quantity per box	Weight per box (oz)	UPC No.
193-B	2 1/8	16	100	4	15962
193-G	2 1/8	16	100	4	15970
193-R	2 1/8	16	100	4	15964
193-W	2 1/8	16	100	4	15968
193-Y	2 1/8	16	100	4	15966



## PUSH PINS

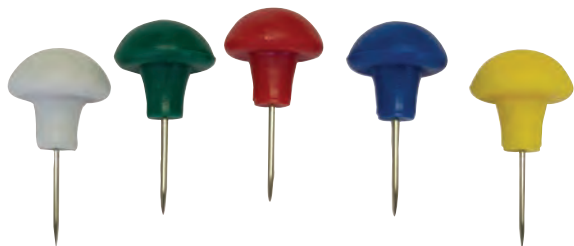

### Osborne No. 183

Nickel plated. Packed 100 pcs. per box. Available in 5 colors: blue, green, yred, yellow & white. They all are 19 gauge.

Osborne No.	Color de la cabeza	Head Diameter (inches)	Overall (inches)	Weight/box (oz)	UPC No.
183-B	Blue	1/2	1 1/4	7	16024
183-G	Green	1/2	1 1/4	7	16026
183-R	Red	1/2	1 1/4	7	16030
183-W	White	1/2	1 1/4	7	16022
183-Y	Yellow	1/2	1 1/4	7	16028

## TWIST PINS

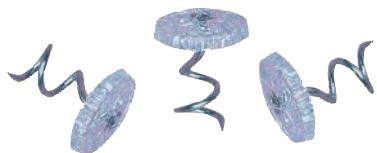

### Osborne No. 199

Nickel plated. Clear plastic heads. Used to affix arm chair slip covers and other projects. Packed 100 pcs. per box or in bulk 5,000 pcs. per box **Osborne No. 199-5000**.

Osborne No.	Length (inches)	Gauge	Head diameter (inches)	Weight per box (oz)	UPC No.
<b>199</b>	1/2	21	3/8	2	16012
<b>199-5000</b>	1/2	21	3/8	24	16014

## GLASS HEAD PINS

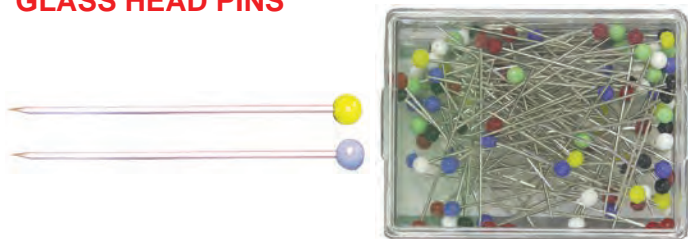

### Osborne No. 178 & 181

Nickel plated. High quality steel. Round glass heads. Packed 100 pcs. per box. Assorted colors. It can withstand heat.

Osborne No.	Overall (inches)	Gauge	Head diameter (in)	Weight per box (oz)	UPC No.
<b>178</b>	2	21	11/64	2	16018
<b>181</b>	1 1/4	23	1/8	2	16020

**Art.Nr. 1011**

**Polsterhammer Magnetisch**

**Upholsterer's Hammer**

**Marteau Garnisseur**

**Kopf/Head/Tête 125mm - 12mm/10mm**

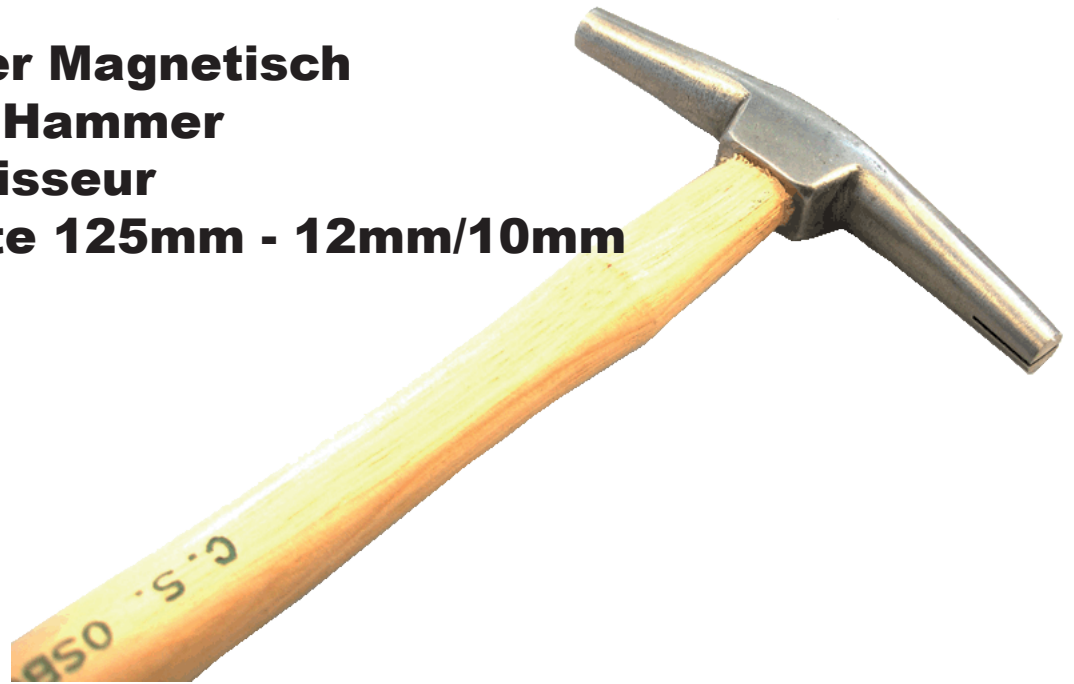

**Gerhard Weyland KG**

Auf der Aeumes 10-12

58636 Iserlohn

Tel +49 (0)2371 22741

Fax +49 (0)2371 27220

info@weyland.de / www.weyland.de

## Ernst Werner Addendum

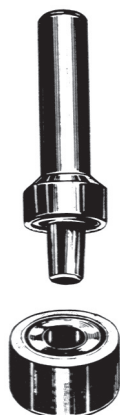
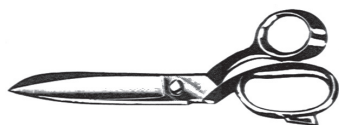

Artikel	UPC	Article	Artikel	Article
684-8		Fabric Shear	Zuschneideschere 8"	Ciseau de Tailleur coudés 8"
684-9		Fabric Shear	Zuschneideschere 9"	Ciseau de Tailleur coudés 9"
684-10		Fabric Shear	Zuschneideschere 10"	Ciseau de Tailleur coudés 10"
684-12		Fabric Shear	Zuschneideschere 12"	Ciseau de Tailleur coudés 12"
684L-8		Fabric Shear Left Hand	Zuschneideschere Linkshänder 8"	Ciseau de Tailleur coudés de gauche 8"
684L-9		Fabric Shear Left Hand	Zuschneideschere Linkshänder 9"	Ciseau de Tailleur coudés de gauche 9"
684L-10		Fabric Shear Left Hand	Zuschneideschere Linkshänder 10"	Ciseau de Tailleur coudés de gauche 10"
684L-12		Fabric Shear Left Hand	Zuschneideschere Linkshänder 12"	Ciseau de Tailleur coudés de gauche 12"
791D-8		Grommet Die Version DIN	Osenstanze 8 DIN	Rivoir à Oeillets 8 DIN
791D-10		Grommet Die Version DIN	Osenstanze 10 DIN	Rivoir à Oeillets 10 DIN
791D-12		Grommet Die Version DIN	Osenstanze 12 DIN	Rivoir à Oeillets 12 DIN
791D-14		Grommet Die Version DIN	Osenstanze 14 DIN	Rivoir à Oeillets 14 DIN
791D-16		Grommet Die Version DIN	Osenstanze 16 DIN	Rivoir à Oeillets 16 DIN
791D-18		Grommet Die Version DIN	Osenstanze 18 DIN	Rivoir à Oeillets 18 DIN
791D-20		Grommet Die Version DIN	Osenstanze 20 DIN	Rivoir à Oeillets 20 DIN
791D-25		Grommet Die Version DIN	Osenstanze 25 DIN	Rivoir à Oeillets 25 DIN
791D-32		Grommet Die Version DIN	Osenstanze 32 DIN	Rivoir à Oeillets 32 DIN
791D-36		Grommet Die Version DIN	Osenstanze 36 DIN	Rivoir à Oeillets 36 DIN
791D-40		Grommet Die Version DIN	Osenstanze 40 DIN	Rivoir à Oeillets 40 DIN
791HB-00		Grommet Die Version H+B = 7mm	Osenstanze 00 H+B 7 mm	Rivoir à Oeillets 00 H+B 7 mm
791HB-0		Grommet Die Version H+B = 8mm	Osenstanze 0 H+B 8 mm	Rivoir à Oeillets 0 H+B 8 mm
791HB-1		Grommet Die Version H+B = 9mm	Osenstanze 1 H+B 9 mm	Rivoir à Oeillets 1 H+B 9 mm
791HB-2		Grommet Die Version H+B = 10mm	Osenstanze 2 H+B 10 mm	Rivoir à Oeillets 2 H+B 10 mm
791HB-3		Grommet Die Version H+B = 11mm	Osenstanze 3 H+B 11 mm	Rivoir à Oeillets 3 H+B 11 mm
791HB-4		Grommet Die Version H+B = 12mm	Osenstanze 4 H+B 12 mm	Rivoir à Oeillets 4 H+B 12 mm
791HB-5		Grommet Die Version H+B = 13mm	Osenstanze 5 H+B 13 mm	Rivoir à Oeillets 5 H+B 13 mm
791HB-6		Grommet Die Version H+B = 14mm	Osenstanze 6 H+B 14 mm	Rivoir à Oeillets 6 H+B 14 mm
791HB-7		Grommet Die Version H+B = 15mm	Osenstanze 7 H+B 15 mm	Rivoir à Oeillets 7 H+B 15 mm
791HB-8		Grommet Die Version H+B = 16mm	Osenstanze 8 H+B 16 mm	Rivoir à Oeillets 8 H+B 16 mm
791HB-9		Grommet Die Version H+B = 17mm	Osenstanze 9 H+B 17 mm	Rivoir à Oeillets 9 H+B 17 mm
791HB-10		Grommet Die Version H+B = 20mm	Osenstanze 10 H+B 20 mm	Rivoir à Oeillets 10 H+B 20 mm
791HB-11		Grommet Die Version H+B = 22mm	Osenstanze 11 H+B 22 mm	Rivoir à Oeillets 11 H+B 22 mm
791HB-12		Grommet Die Version H+B = 24mm	Osenstanze 12 H+B 24 mm	Rivoir à Oeillets 12 H+B 24 mm
791HB-13		Grommet Die Version H+B = 26mm	Osenstanze 13 H+B 26 mm	Rivoir à Oeillets 13 H+B 26 mm
791HB-14		Grommet Die Version H+B = 29mm	Osenstanze 14 H+B 29 mm	Rivoir à Oeillets 14 H+B 29 mm
791-16x9		Grommet Die oval, Size 16x9mm	Osenstanze oval 16x9 mm	Rivoir à Oeillets ovales 16x9mm
791-22		Grommet Die oval, Size 22x13mm	Osenstanze oval 22x13 mm	Rivoir à Oeillets ovales 22x13mm
791-42		Grommet Die oval, Size 42x22mm	Osenstanze oval 42x22 mm	Rivoir à Oeillets ovales 42x22mm

## Ernst Werner Addendum



Artikel	UPC	Article	Artikel	Article
793	67375	Auto Durabe	Autodurrabe	Autodurrabe
795/1		Punches for Automatic Machines	Automatenlocheisen	Emporte-pièce pour automatique
795/2		Punches for Automatic Machines	Automatenlocheisen	Emporte-pièce pour automatique
795/3		Punches for Automatic Machines	Automatenlocheisen	Emporte-pièce pour automatique
795/4		Punches for Automatic Machines	Automatenlocheisen	Emporte-pièce pour automatique
795/5		Punches for Automatic Machines	Automatenlocheisen	Emporte-pièce pour automatique
795/6		Punches for Automatic Machines	Automatenlocheisen	Emporte-pièce pour automatique
795/7		Punches for Automatic Machines	Automatenlocheisen	Emporte-pièce pour automatique
795/8		Punches for Automatic Machines	Automatenlocheisen	Emporte-pièce pour automatique
795/9		Punches for Automatic Machines	Automatenlocheisen	Emporte-pièce pour automatique
795/10		Punches for Automatic Machines	Automatenlocheisen	Emporte-pièce pour automatique
795/11		Punches for Automatic Machines	Automatenlocheisen	Emporte-pièce pour automatique
795/12		Punches for Automatic Machines	Automatenlocheisen	Emporte-pièce pour automatique
795/13		Punches for Automatic Machines	Automatenlocheisen	Emporte-pièce pour automatique
795/14		Punches for Automatic Machines	Automatenlocheisen	Emporte-pièce pour automatique
795/15		Punches for Automatic Machines	Automatenlocheisen	Emporte-pièce pour automatique
795/16		Punches for Automatic Machines	Automatenlocheisen	Emporte-pièce pour automatique
795/20		Punches for Automatic Machines	Automatenlocheisen	Emporte-pièce pour automatique
847A-1		Belt Punch	Rundlocheisen 1 mm	Emporte-pièce 1 mm
847A-2		Belt Punch	Rundlocheisen 2 mm	Emporte-pièce 2 mm
847A-3		Belt Punch	Rundlocheisen 3 mm	Emporte-pièce 3 mm
847A-4		Belt Punch	Rundlocheisen 4 mm	Emporte-pièce 4 mm
847A-5		Belt Punch	Rundlocheisen 5 mm	Emporte-pièce 5 mm
847A-6		Belt Punch	Rundlocheisen 6 mm	Emporte-pièce 6 mm
847A-7		Belt Punch	Rundlocheisen 7 mm	Emporte-pièce 7 mm
847A-8		Belt Punch	Rundlocheisen 8 mm	Emporte-pièce 8 mm
847A-9		Belt Punch	Rundlocheisen 9 mm	Emporte-pièce 9 mm
847A-10		Belt Punch	Rundlocheisen 10 mm	Emporte-pièce 10 mm
847A-11		Belt Punch	Rundlocheisen 11 mm	Emporte-pièce 11 mm
847A-12		Belt Punch	Rundlocheisen 12 mm	Emporte-pièce 12 mm
847A-13		Belt Punch	Rundlocheisen 13 mm	Emporte-pièce 13 mm
847A-14		Belt Punch	Rundlocheisen 14 mm	Emporte-pièce 14 mm
847A-15		Belt Punch	Rundlocheisen 15 mm	Emporte-pièce 15 mm
847A-16		Belt Punch	Rundlocheisen 16 mm	Emporte-pièce 16 mm
847A-17		Belt Punch	Rundlocheisen 17 mm	Emporte-pièce 17 mm
847A-18		Belt Punch	Rundlocheisen 18 mm	Emporte-pièce 18 mm
847A-19		Belt Punch	Rundlocheisen 19 mm	Emporte-pièce 19 mm
847A-20		Belt Punch	Rundlocheisen 20 mm	Emporte-pièce 20 mm
847A-24		Belt Punch	Rundlocheisen 20 mm	Emporte-pièce 20 mm
847A-25		Belt Punch	Rundlocheisen 20 mm	Emporte-pièce 20 mm

## Ernst Werner Addendum



Artikel	UPC	Article	Artikel	Article
849H-2		Oval Punch	Kappenlocheisen oval Nr. 2 6x2 mm	Emporte-pièce d'arche ovale Nr. 2 6x2 mm
849H-3		Oval Punch	Kappenlocheisen oval Nr. 3 8x2,5 mm	Emporte-pièce d'arche ovale Nr. 3 8x2,5 mm
849H-4		Oval Punch	Kappenlocheisen oval Nr. 4 10x3 mm	Emporte-pièce d'arche ovale Nr. 4 10x3 mm
849H-5		Oval Punch	Kappenlocheisen oval Nr. 5 12x3 mm	Emporte-pièce d'arche ovale Nr. 5 12x3 mm
849H-6		Oval Punch	Kappenlocheisen oval Nr. 6 14x3,5mm	Emporte-pièce d'arche ovale Nr. 6 14x3,5mm
849H-7		Oval Punch	Kappenlocheisen oval Nr. 7 15x3,5 mm	Emporte-pièce d'arche ovale Nr. 7 15x3,5 mm
849H-8		Oval Punch	Kappenlocheisen oval Nr. 8 18x4 mm	Emporte-pièce d'arche ovale Nr. 8 18x4 mm
849H-9		Oval Punch	Kappenlocheisen oval Nr. 9 20x4 mm	Emporte-pièce d'arche ovale Nr. 9 20x4 mm
849H-10		Oval Punch	Kappenlocheisen oval Nr. 10 22x4mm	Emporte-pièce d'arche ovale Nr. 10 22x4mm
849H-11		Oval Punch	Kappenlocheisen oval Nr. 11 24x4,5 mm	Emporte-pièce d'arche ovale Nr. 11 24x4,5 mm
849H-12		Oval Punch	Kappenlocheisen oval Nr. 12 26x4,5 mm	Emporte-pièce d'arche ovale Nr. 12 26x4,5 mm
849H-13		Oval Punch	Kappenlocheisen oval Nr. 13 28x4,5 mm	Emporte-pièce d'arche ovale Nr. 13 28x4,5 mm
849H-14		Oval Punch	Kappenlocheisen oval Nr. 14 31x5 mm	Emporte-pièce d'arche ovale Nr. 14 31x5 mm
849H-15		Oval Punch	Kappenlocheisen oval Nr. 15 34x5 mm	Emporte-pièce d'arche ovale Nr. 15 34x5 mm
849H-16		Oval Punch	Kappenlocheisen oval Nr. 16 36x5,5 mm	Emporte-pièce d'arche ovale Nr. 16 36x5,5 mm
849H-17		Oval Punch	Kappenlocheisen oval Nr. 17 38x5,5 mm	Emporte-pièce d'arche ovale Nr. 17 38x5,5 mm
849H-18		Oval Punch	Kappenlocheisen oval Nr. 18 41x8 mm	Emporte-pièce d'arche ovale Nr. 18 41x8 mm
849H-19		oval Punch 16x9mm	Kappenlocheisen oval 16x9	Emporte-pièce d'arche ovale Nr. 19
849H-20		oval Punch 22x13mm	Kappenlocheisen oval 22x13	Emporte-pièce d'arche ovale Nr. 20
849H-21		oval Punch 23x13mm	Kappenlocheisen oval 23x13	Emporte-pièce d'arche ovale Nr. 21
849H-22		oval Punch 42x22mm	Kappenlocheisen oval 42x22	Emporte-pièce d'arche ovale Nr. 22
849H23x5		oval Punch 23x5mm	Kappenlocheisen oval 23x5	Emporte-pièce d'arche ovale 23x5
849H27x7		oval Punch 27x7mm	Kappenlocheisen oval 27x7	Emporte-pièce d'arche ovale 27x7
849H30x15		oval Punch 30x15mm	Kappenlocheisen oval 30x15	Emporte-pièce d'arche ovale 30x15
849H38x9		oval Punch 38x9mm	Kappenlocheisen oval 38x9	Emporte-pièce d'arche ovale 38x9
849H41x21		oval Punch 41x21mm	Kappenlocheisen oval 41x21	Emporte-pièce d'arche ovale 41x21
849H42x21		oval Punch 42x21mm	Kappenlocheisen oval 42x21	Emporte-pièce d'arche ovale 42x21
849E16x16		Punch 4-corner16x16	Kappenlocheisen eckig 16x16	Emporte-pièce d'arche 16x16
849LL17x7		Oblong Punch 17x7mm	Langlocheisen 17x7mm	
849LL25x15		Oblong Punch 25x15mm	Langlocheisen 25x15mm	
849LL27x13		Oblong Punch 27x13mm	Langlocheisen 27x13	
849LL40x12		Oblong Punch 40x12mm	Langlocheisen 40x12	
849LL42x10		Oblong Punch 42x10mm	Langlocheisen 42x10	
849LL50x20		Oblong Punch 50x20mm	Langlocheisen 50x20	

## Ernst Werner Addendum

Artikel	UPC	Article	Artikel	Article
854-2		Arch Punch	Henkellocheisen	Emporte-pièce d'arche
854-3		Arch Punch	Henkellocheisen	Emporte-pièce d'arche
854-4		Arch Punch	Henkellocheisen	Emporte-pièce d'arche
854-5		Arch Punch	Henkellocheisen	Emporte-pièce d'arche
854-6		Arch Punch	Henkellocheisen	Emporte-pièce d'arche
854-7		Arch Punch	Henkellocheisen	Emporte-pièce d'arche
854-8		Arch Punch	Henkellocheisen	Emporte-pièce d'arche
854-9		Arch Punch	Henkellocheisen	Emporte-pièce d'arche
854-10		Arch Punch	Henkellocheisen	Emporte-pièce d'arche
854-11		Arch Punch	Henkellocheisen	Emporte-pièce d'arche
854-12		Arch Punch	Henkellocheisen	Emporte-pièce d'arche
854-13		Arch Punch	Henkellocheisen	Emporte-pièce d'arche
854-14		Arch Punch	Henkellocheisen	Emporte-pièce d'arche
854-15		Arch Punch	Henkellocheisen	Emporte-pièce d'arche
854-16		Arch Punch	Henkellocheisen	Emporte-pièce d'arche
854-17		Arch Punch	Henkellocheisen	Emporte-pièce d'arche
854-18		Arch Punch	Henkellocheisen	Emporte-pièce d'arche
854-19		Arch Punch	Henkellocheisen	Emporte-pièce d'arche
854-20		Arch Punch	Henkellocheisen	Emporte-pièce d'arche
854-21		Arch Punch	Henkellocheisen	Emporte-pièce d'arche
854-22		Arch Punch	Henkellocheisen	Emporte-pièce d'arche
854-23		Arch Punch	Henkellocheisen	Emporte-pièce d'arche
854-24		Arch Punch	Henkellocheisen	Emporte-pièce d'arche
854-25		Arch Punch	Henkellocheisen	Emporte-pièce d'arche
854-26		Arch Punch	Henkellocheisen	Emporte-pièce d'arche
854-27		Arch Punch	Henkellocheisen	Emporte-pièce d'arche
854-28		Arch Punch	Henkellocheisen	Emporte-pièce d'arche
854-29		Arch Punch	Henkellocheisen	Emporte-pièce d'arche
854-30		Arch Punch	Henkellocheisen	Emporte-pièce d'arche
854-31		Arch Punch	Henkellocheisen	Emporte-pièce d'arche
854-32		Arch Punch	Henkellocheisen	Emporte-pièce d'arche
854-33		Arch Punch	Henkellocheisen	Emporte-pièce d'arche
854-34		Arch Punch	Henkellocheisen	Emporte-pièce d'arche
854-35		Arch Punch	Henkellocheisen	Emporte-pièce d'arche
854-36		Arch Punch	Henkellocheisen	Emporte-pièce d'arche
854-37		Arch Punch	Henkellocheisen	Emporte-pièce d'arche
854-38		Arch Punch	Henkellocheisen	Emporte-pièce d'arche
854-39		Arch Punch	Henkellocheisen	Emporte-pièce d'arche
854-40		Arch Punch	Henkellocheisen	Emporte-pièce d'arche
854-41		Arch Punch	Henkellocheisen	Emporte-pièce d'arche
854-42		Arch Punch	Henkellocheisen	Emporte-pièce d'arche
854-43		Arch Punch	Henkellocheisen	Emporte-pièce d'arche
854-44		Arch Punch	Henkellocheisen	Emporte-pièce d'arche
854-45		Arch Punch	Henkellocheisen	Emporte-pièce d'arche
854-46		Arch Punch	Henkellocheisen	Emporte-pièce d'arche
854-47		Arch Punch	Henkellocheisen	Emporte-pièce d'arche
854-48		Arch Punch	Henkellocheisen	Emporte-pièce d'arche
854-49		Arch Punch	Henkellocheisen	Emporte-pièce d'arche
854-50		Arch Punch	Henkellocheisen	Emporte-pièce d'arche
854-60		Arch Punch	Henkellocheisen	Emporte-pièce d'arche
854-64		Arch Punch	Henkellocheisen	Emporte-pièce d'arche
854-65		Arch Punch	Henkellocheisen	Emporte-pièce d'arche
854-68		Arch Punch	Henkellocheisen	Emporte-pièce d'arche

